

SOKKIA

Series30R

SET230R/R3

SET330R/R3

SET530R/R3

SET630R

Reflectorless Total Station



SET230R3/330R3/530R3:
Class 3R Laser Product

SET230R/330R/530R/630R:
Class 2 Laser Product

Class 1 LED Product

OPERATOR'S MANUAL



Li-ion

CONTAINS Li-ion BATTERY.
MUST BE RECYCLED OR DISPOSED OF PROPERLY.

Japan
Surveying
Instruments

JSIMA

Manufacturers
Association

:This is the mark of the Japan Surveying
Instruments Manufacturers Association.

SOKKIA

Series30R

SET230R/R3

SET330R/R3

SET530R/R3

SET630R

Reflectorless Total Station

SET230R3/330R3/530R3:
Class 3R Laser Product

SET230R/330R/530R/630R:
Class 2 Laser Product

Class 1 LED Product





OPERATOR'S MANUAL

- Thank you for selecting the SET230R/230R3/330R/330R3/530R/530R3/630R.
- Before using the instrument, please read this operator's manual carefully.
- Verify that all equipment is included.
☞ "27.1 Standard Equipment"
- SET has a function to output data saved in the SET to a connected host computer. Command operations from a host computer can also be performed. For details, refer to "Interfacing with the SOKKIA SDR Electronic Field Book" and "Command Explanations" manuals and ask your Sokkia agent.
- The specifications and general appearance of the instrument may be altered at any time and may differ from those appearing in brochures and this manual.
- Some of the diagrams shown in this manual may be simplified for easier understanding.

HOW TO READ THIS MANUAL

Symbols

The following conventions are used in this manual.

-  : Indicates precautions and important items which should be read before operations.
-  : Indicates the chapter title to refer to for additional information.
-  : Indicates supplementary explanation.
-  : Indicates an explanation for a particular term or operation.
- [DIST] etc. : Indicates softkeys on the display.
- {ESC} etc. : Indicates operation keys on the SET or wireless keyboard.
- <S-O> etc. : Indicates screen titles.

Screens and illustrations

- Except where stated, "SET230R" means "SET230R/230R3", "SET330R" means "SET330R/330R3" and "SET530R" means "SET530R/530R3" in this manual.
- Screens and illustrations appearing in this manual are of SET530R.
- Location of softkeys in screens used in procedures is based on the factory setting. It is possible to change the allocation of softkeys in Meas mode.
 What are softkeys: "4.1 Parts of the Instrument", Softkeys allocation: "24.2 Allocating Key Functions"
- Kodak Gray Card: **KODAK** is a registered trademark of Eastman Kodak Company.

Operation procedure

- Learn basic key operations in "5. BASIC OPERATION" before you read each measurement procedure.
- Measurement procedures are based on continuous measurement. Some information about procedures when other measurement options are selected can be found in "Note" (.
- For selecting options and inputting figures, see "5.1 Basic Key Operation".

READ THIS
FIRST

INTRODUCTION

PREPARATION
FOR
MEASURE-
MENT

MEASURE-
MENT
-MEASURE-
MENT
MODE -

1.	PRECAUTIONS FOR SAFE OPERATION	1
2.	PRECAUTIONS	5
3.	LASER SAFETY INFORMATION	7
4.	SET FUNCTIONS	10
4.1	Parts of the Instrument	10
4.2	Mode Diagram	14
5.	BASIC OPERATION	15
5.1	Basic Key Operation	15
5.2	Display Functions	19
6.	USING THE BATTERY	22
6.1	Battery Charging	22
6.2	Installing / Removing the Battery	23
7.	SETTING UP THE INSTRUMENT	25
7.1	Centering	25
7.2	Levelling	26
8.	FOCUSSING AND TARGET SIGHTING	30
9.	POWER ON	32
10.	ANGLE MEASUREMENT	33
10.1	Measuring the Horizontal Angle between Two Points (Horizontal Angle 0°)	33
10.2	Setting the Horizontal Angle to a Required Value (Horizontal Angle Hold)	34
10.3	Horizontal Angle Repetition	35
10.4	Angle Measurement and Outputting the Data	36
11.	DISTANCE MEASUREMENT	37
11.1	Returned Signal Checking	38
11.2	Distance and Angle Measurement	39
11.3	Recalling the Measured Data	40
11.4	Distance Measurement and Outputting the Data	41
11.5	REM Measurement	42
12.	COORDINATE MEASUREMENT	44
12.1	Entering Instrument Station Data	44
12.2	Azimuth Angle Setting	47
12.3	3-D Coordinate Measurement	49
13.	RESECTION MEASUREMENT	51
13.1	Coordinate Resection Measurement	52
13.2	Height Resection Measurement	55

CONTENTS

MEASURE-
MENT
-MEASURE-
MENT
MODE -

14. SETTING-OUT MEASUREMENT	59
14.1 Distance Setting-out Measurement	59
14.2 Coordinates Setting-out Measurement	63
14.3 REM Setting-out Measurement	65
15. SETTING-OUT LINE	67
15.1 Defining Baseline	67
15.2 Setting-out Line Point	70
15.3 Setting-out Line Line	71
16. POINT PROJECTION	74
16.1 Defining Baseline	74
16.2 Point Projection	75
17. Offset Measurement	77
17.1 Single-distance Offset Measurement	77
17.2 Angle Offset Measurement	79
17.3 Two-distance Offset Measurement	81
18. MISSING LINE MEASUREMENT	83
18.1 Measuring the Distance between 2 or more Points	83
18.2 Changing the Starting Point	85
19. SURFACE AREA CALCULATION	87
20. RECORDING DATA - RECORD MENU -	91
20.1 Recording Instrument Station Data	91
20.2 Recording Angle Measurement Data	93
20.3 Recording Distance Measurement Data	94
20.4 Recording Coordinate Data	95
20.5 Recording Distance and Coordinate Data	96
20.6 Recording Notes	97
20.7 Reviewing JOB Data	98
21. SELECTING / DELETING A JOB	100
21.1 Selecting a JOB	100
21.2 Deleting a JOB	102
22. REGISTERING/DELETING DATA	104
22.1 Registering/Deleting Known Point Data	104
22.2 Reviewing Known Point Data	107
22.3 Registering/Deleting Codes	108
22.4 Reviewing Codes	109
23. OUTPUTTING JOB DATA	111

MANAGING THE
DATA
-MEMORY
MODE-

ADDITIONAL
DETAILS
MODE-

TROUBLE-
SHOOTING

INFORMATION
ABOUT
SET



24. CHANGING THE SETTINGS	113
24.1 Changing Instrument Options	113
24.2 Allocating Key Functions	120
24.3 Changing Password	123
24.4 Restoring Default Settings	124
25. WARNING AND ERROR MESSAGES	126
26. CHECKS AND ADJUSTMENTS	130
26.1 Plate Level	130
26.2 Circular Level	131
26.3 Tilt Sensor	132
26.4 Collimation	137
26.5 Reticle	138
26.6 Optical Plummet	140
26.7 Additive Distance Constant	142
26.8 Guide Light	143
27. STANDARD EQUIPMENT AND OPTIONAL ACCESSORIES	147
27.1 Standard Equipment	147
27.2 Optional Accessories	149
27.3 Target System	153
27.4 Power Supply System	155
28. SPECIFICATIONS	157
29. REGULATIONS	163
30. EXPLANATION	166
30.1 Manually Indexing the Vertical Circle by Face Left, Face Right Measurement	166
30.2 Atmospheric Correction for High Precision Dis- tance Measurement	167

1. PRECAUTIONS FOR SAFE OPERATION

For the safe use of the product and prevention of injury to operators and other persons as well as prevention of property damage, items which should be observed are indicated by an exclamation point within a triangle used with WARNING and CAUTION statements in this operator's manual.

The definitions of the indications are listed below. Be sure you understand them before reading the manual's main text.

Definition of Indication

 WARNING	Ignoring this indication and making an operation error could possibly result in death or serious injury to the operator.
 CAUTION	Ignoring this indication and making an operation error could possibly result in personal injury or property damage.



This symbol indicates items for which caution (hazard warnings inclusive) is urged. Specific details are printed in or near the symbol.



This symbol indicates items which are prohibited. Specific details are printed in or near the symbol.









This symbol indicates items which must always be performed. Specific details are printed in or near the symbol.





1. PRECAUTIONS FOR SAFE OPERATION

General

Warning









-  Do not use the unit in areas exposed to high amounts of dust or ash, in areas where there is inadequate ventilation, or near combustible materials. An explosion could occur.
-  Do not perform disassembly or rebuilding. Fire, electric shock, burns, or hazardous radiation exposure could result.
-  Never look at the sun through the telescope. Loss of eyesight could result.
-  Do not look at reflected sunlight from a prism or other reflecting object through the telescope. Loss of eyesight could result.
-  Direct viewing of the sun during sun observation will cause loss of eyesight. Use solar filter (option) for sun observation.
 "27.2 Optional Accessories"
-  When securing the instrument in the carrying case make sure that all catches, including the side catches, are closed. Failure to do so could result in the instrument falling out while being carried, causing injury.

Caution

-  Do not use the carrying case as a footstool. The case is slippery and unstable so a person could slip and fall off it.
-  Do not place the instrument in a case with a damaged catch, belt or handle. The case or instrument could be dropped and cause injury.
-  Do not wield or throw the plumb bob. A person could be injured if struck.
-  Secure handle to main unit with locking screws. Failure to properly secure the handle could result in the unit falling off while being carried, causing injury.
-  Tighten the adjustment tribrach clamp securely. Failure to properly secure the clamp could result in the tribrach falling off while being carried, causing injury.

Power Supply

Warning

-  Do not use voltage other than the specified power supply voltage. Fire or electrical shock could result.
-  Do not use damaged power cords, plugs or loose outlets. Fire or electric shock could result.
-  Do not use power cords other than those designated. Fire could result.
-  Do not place articles such as clothing on the battery charger while charging batteries. Sparks could be induced, leading to fire.
-  Use only the specified battery charger to recharge batteries. Other chargers may be of different voltage rating or polarity, causing sparking which could lead to fire or burns.
-  Do not heat or throw batteries into fire. An explosion could occur, resulting in injury.
-  To prevent shorting of the battery in storage, apply insulating tape or equivalent to the terminals. Otherwise shorting could occur resulting in fire or burns.
-  Do not use batteries or the battery charger if wet. Resultant shorting could lead to fire or burns.
-  Do not connect or disconnect power supply plugs with wet hands. Electric shock could result.





Caution

-  Do not touch liquid leaking from batteries. Harmful chemicals could cause burns or blisters.

1. PRECAUTIONS FOR SAFE OPERATION



Tripod

Warning

-  When mounting the instrument to the tripod, tighten the centering screw securely. Failure to tighten the screw properly could result in the instrument falling off the tripod, causing injury.
-  Tighten securely the leg fixing screws of the tripod on which the instrument is mounted. Failure to tighten the screws could result in the tripod collapsing, causing injury.
-  Do not carry the tripod with the tripod shoes pointed at other persons. A person could be injured if struck by the tripod shoes.
-  Keep hands and feet away from the tripod shoes when fixing the tripod in the ground. A hand or foot stab wound could result.
-  Tighten the leg fixing screws securely before carrying the tripod. Failure to tighten the screws could lead to the tripod legs extending, causing injury.

Wireless Keyboard

Caution

-  Do not perform disassembly or rebuilding. Fire, electric shock or burns could result.
-  Do not use batteries if wet and do not touch batteries with wet hands. Resultant shorting could lead to fire or burns.
-  When changing batteries, follow the procedure described below. If you try to open the battery cover the wrong way or try to force it open, you might injure yourself.

2. PRECAUTIONS

Tribrach Clamp

- When the instrument is shipped, the tribrach clamp is held firmly in place with a locking screw to prevent the instrument from shifting on the levelling base. Before using the instrument the first time, loosen this screw with a screwdriver. And before transporting it, tighten the locking screw to fasten the tribrach clamp in place so that it will not shift on the levelling base.

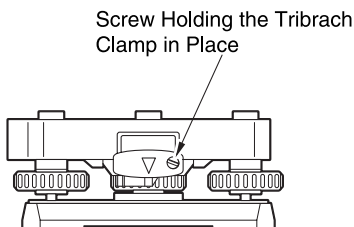

Precautions concerning water and dust resistance

SET conforms to IP66 specifications for waterproofing and dust resistance when the battery cover is closed and connector caps are attached correctly.

- Be sure to close the battery cover and correctly attach the connector caps to protect the SET from moisture and dust particles.
- Make sure that moisture or dust particles do not come in contact with the inside of the battery cover, terminal or connectors. Contact with these parts may cause damage to the instrument.
- Make sure that the inside of the carrying case and the instrument are dry before closing the case. If moisture is trapped inside the case, it may cause the instrument to rust.

Other precautions

- If the SET is moved from a warm place to an extremely cold place, internal parts may contract and make the keys difficult to operate. This is caused by cold air trapped inside the hermetically sealed casing. If the keys do not depress, open the battery cover to resume normal functionality. To prevent the keys from becoming stiff, remove the connector caps before moving the SET to a cold place.
- Never place the SET directly on the ground. Sand or dust may cause damage to the screw holes or the centering screw on the base plate.
- Do not aim the telescope at the sun. Use the Solar filter to avoid causing internal damage to the instrument when observing the sun.

 "27.2 Optional Accessories"

- Protect the SET from heavy shocks or vibration.
- Never carry the SET on the tripod to another site.
- Turn the power off before removing the battery.

2. PRECAUTIONS

- When placing the SET in its case, first remove its battery and place it in the case in accordance with the layout plan.

Maintenance

- Always clean the instrument before returning it to the case. The lens requires special care. First, dust it off with the lens brush to remove tiny particles. Then, after providing a little condensation by breathing on the lens, wipe it with the wiping cloth.
- If the display is dirty, carefully wipe it with a soft, dry cloth. To clean other parts of the instrument or the carrying case, lightly moisten a soft cloth in a mild detergent solution. Wring out excess water until the cloth is slightly damp, then carefully wipe the surface of the unit. Do not use any organic solvents or alkaline cleaning solutions.
- Store the SET in a dry room where the temperature remains fairly constant.
- Check the tripod for loose fit and loose screws.
- If any trouble is found on the rotatable portion, screws or optical parts (e.g. lens), contact your SOKKIA agent.
- When the instrument is not used for a long time, check it at least once every 3 months.

"26. CHECKS AND ADJUSTMENTS"

- When removing the SET from the carrying case, never pull it out by force. The empty carrying case should be closed to protect it from moisture.
- Check the SET for proper adjustment periodically to maintain the instrument accuracy.

3. LASER SAFETY INFORMATION

Series 30R is classified as the following class of Laser Product and LED Product according to IEC Standard Publication 60825-1 Amd. 2: 2001 and United States Government Code of Federal Regulation FDA CDRH 21CFR Part1040.10 and 1040.11 (Complies with FDA performance standards for laser products except for deviations pursuant to Laser Notice No.50, dated July 26, 2001.)

SET230R3/330R3/530R3

- EDM device in objective lens: Class 3R Laser Product (Class 1 Laser Product when prism or reflective sheet in Config mode as target)
- Guide light (optional function): Class 1 LED Product

SET230R/330R/530R/630R

- EDM device in objective lens: Class2 Laser Product (Class 1 Laser Product when prism or reflective sheet is selected in Config mode as target)
- Guide light (optional function): Class 1 LED Product

Caution

- EDM device is classified as Class 3R Laser Product (SET230R3/330R3/530R3)/Class 2 Laser Product (SET230R/330R/530R/630R) when reflectorless measurement is selected. When the prism or reflective sheet is selected in Config mode as target, the output is equivalent to the safer class 1.
- The guide light is an optional function.
☞ "27.2 Optional Accessories"

Warning

- Use of controls or adjustments or performance of procedures other than those specified herein may result in hazardous radiation exposure.
- Follow the safety instructions on the labels attached to the instrument as well as in this manual to ensure safe use of this laser and LED product.

SET230R3/330R3/530R3

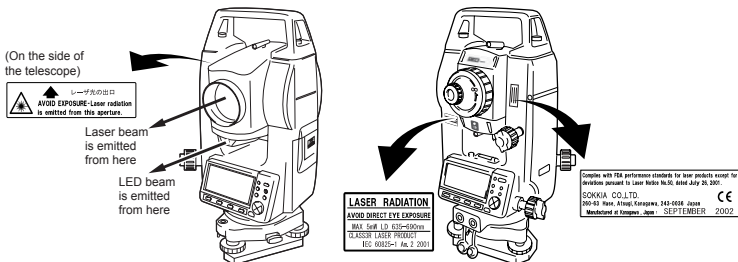

3. LASER SAFETY INFORMATION

SET230R/330R/530R/630R

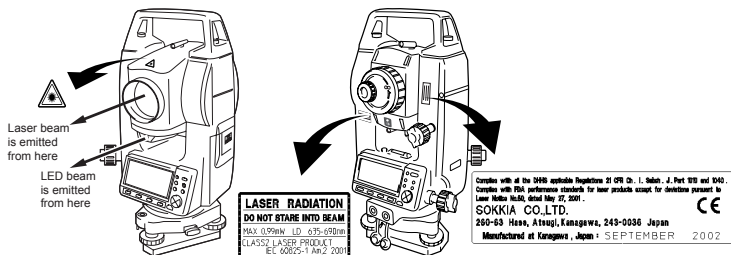

- Never point the laser beam at another person. If the laser beam strikes skin or an eye, it could cause serious injury.
- Do not look directly into the laser beam source. Doing so could cause permanent eye damage.
- Do not stare at the laser beam. Doing so could cause permanent eye damage.
- If an eye injury is caused by exposure to the laser beam, seek immediate medical attention from a licensed ophthalmologist.
- Never look at the laser beam through a telescope, binoculars or other optical instruments. Doing so could cause permanent eye damage. (SET230R3/330R3/530R3 only)
- Sight the targets so that laser beam does not stray from them. (SET230R3/330R3/530R3 only)

⚠ Caution

- Perform checks at start of work and periodic checks and adjustments with the laser beam emitted under normal conditions.
- When the instrument is not being used, turn off the power.
- When disposing of the instrument, destroy the battery connector so that the laser beam cannot be emitted.
- Operate the instrument with due caution to avoid injuries that may be caused by the laser beam unintentionally striking a person in the eye. Avoid setting the instrument at heights at which the path of the laser beam may strike pedestrians or drivers at head height.
- Never point the laser beam at mirrors, windows or surfaces that are highly reflective. The reflected laser beam could cause serious injury.

3. LASER SAFETY INFORMATION

- When using the Laser-pointer function, be sure to turn OFF the output laser after distance measurement is completed. Even if distance measurement is canceled, the Laser-pointer function is still operating and the laser beam continues to be emitted. (After turning ON the Laser-pointer, the laser beam is emitted for 5 minutes, and then automatically switches OFF. But in the Status screen and when target symbol (ex. ) is not displayed in the Measurement mode, the laser beam is not automatically turned off.)
- Only those who have been received training as per the following items shall use this product. (SET230R3/330R3/530R3 only)
 - Read the Operator's manual for usage procedures for this product.
 - Hazardous protection procedures (read this chapter).
 - Requisite protective gear (read this chapter).
 - Accident reporting procedures (stipulate procedures beforehand for transporting the injured and contacting physicians in case there are laser induced injuries).
- Persons working within the range of the laser beam are advised to wear eye protection for Helium Neon radiation. Recommended safety glasses from Yamamoto Optics Co., Ltd. (SET230R3/330R3/530R3 only)
- ①Full Absorption type YL-331 (for He-Ne laser radiation) or ②Maintenance type YL-331M (for visible semiconductor laser radiation)
- Areas in which the lasers are used should be posted with laser warning notices. (SET230R3/330R3/530R3 only)

4. SET FUNCTIONS

4.1 Parts of the Instrument

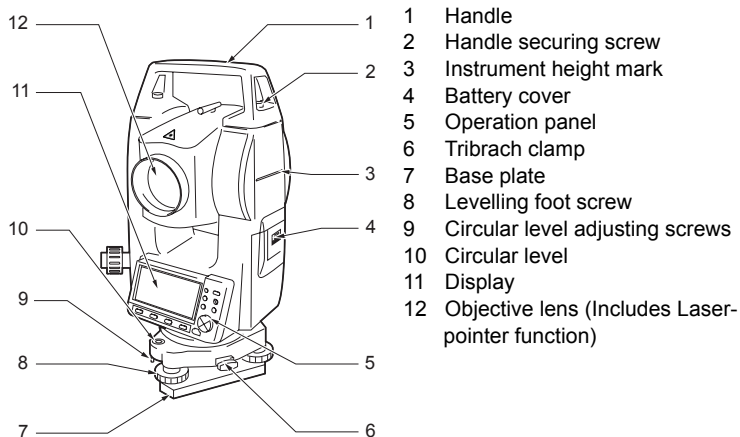

- 1 Handle
- 2 Handle securing screw
- 3 Instrument height mark
- 4 Battery cover
- 5 Operation panel
- 6 Tribrach clamp
- 7 Base plate
- 8 Levelling foot screw
- 9 Circular level adjusting screws
- 10 Circular level
- 11 Display
- 12 Objective lens (Includes Laser-pointer function)

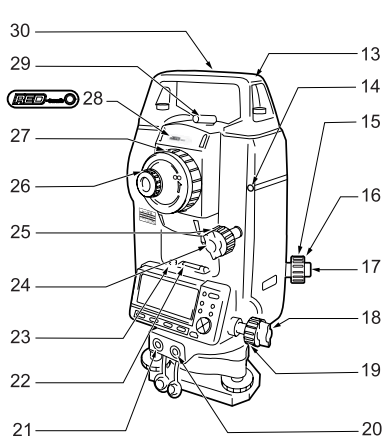

- 13 Tubular compass slot
- 14 Beam detector for wireless keyboard
(Not included on SET630R)
- 15 Optical plummet focussing ring
- 16 Optical plummet reticle cover
- 17 Optical plummet eyepiece
- 18 Horizontal clamp
- 19 Horizontal fine motion screw
- 20 Data input / output connector
(Beside the operation panel on SET630R)
- 21 External power source connector
(Not included on SET630R)
- 22 Plate level
- 23 Plate level adjusting screw
- 24 Vertical clamp
- 25 Vertical fine motion screw
- 26 Telescope eyepiece screw
- 27 Telescope focussing ring
- 28 Laser radiation warning indicator
(Not included on SET230R/330R
530R/630R)
- 29 Peep sight
- 30 Instrument center mark



Peep sight

Use peep sight to aim the SET in the direction of the measurement point. Turn the instrument until the triangle in the peep sight is aligned with the target.



Instrument height mark

The height of the SET is 236mm (from tribrach dish to this mark). "Instrument height" is input when setting instrument station data and is the height from the measuring point (where SET is mounted) to this mark.



Laser-pointer Function

A target can be sighted with a red laser beam in dark locations without the use of the telescope.

Operation panel

"5.1 Basic Key Operation"

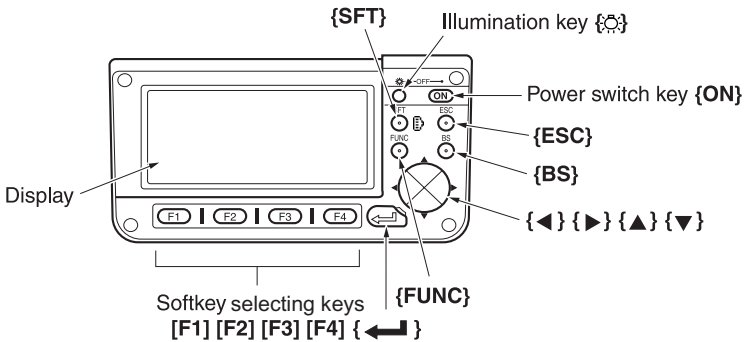

4. SET FUNCTIONS

Laser-emission warning lamp (only SET230R3/330R3/530R3)

Laser-emission warning lamp is red when laser beam is emitted or laser-pointer is used, and laser beam status can be known from the telescope eyepiece side.

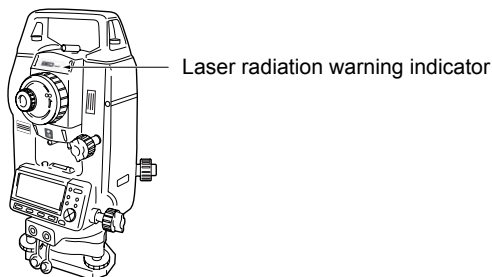

Wireless keyboard (Optional accessory)

☞ "5.1 Basic Key Operation" and "27.2 Optional Accessories"

Caution

- Wireless keyboard cannot be used on SET630R.

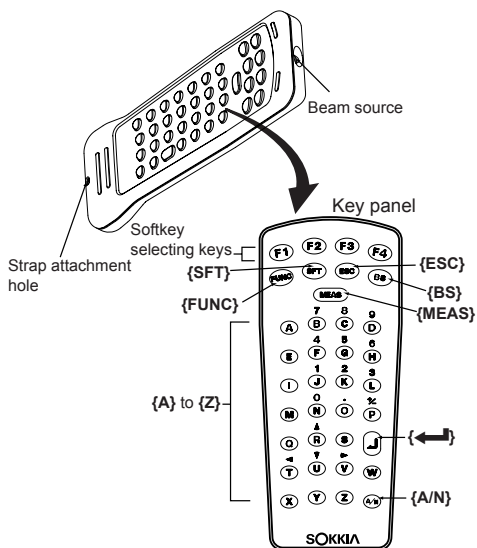

Guide light (Optional function)

 "27.2 Optional Accessories"

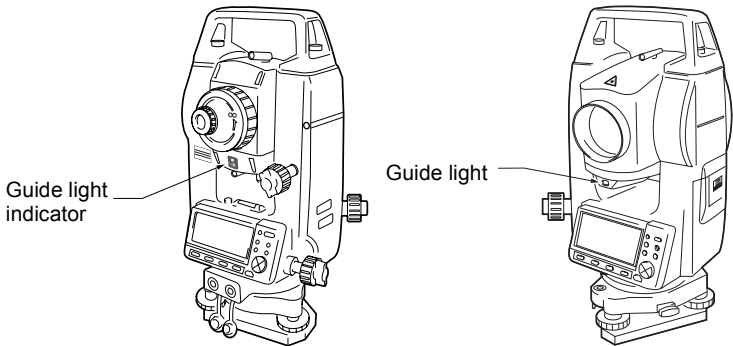

Guide light and Guide light indicator

Setting-out measurement etc. can be carried out effectively using the Guide light. The Guide light is composed of a light that is divided into a red and a green light. A poleman can ascertain the present position by checking the Guide light color.

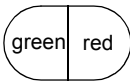

Guide light status

Light status	Meaning
Red	(From position of poleman) Move target left
Green	(From position of poleman) Move target right
Red and Green	Target is at correct horizontal position

The Guide light indicator is lit when the Guide light is ON.

4.2 Mode Diagram

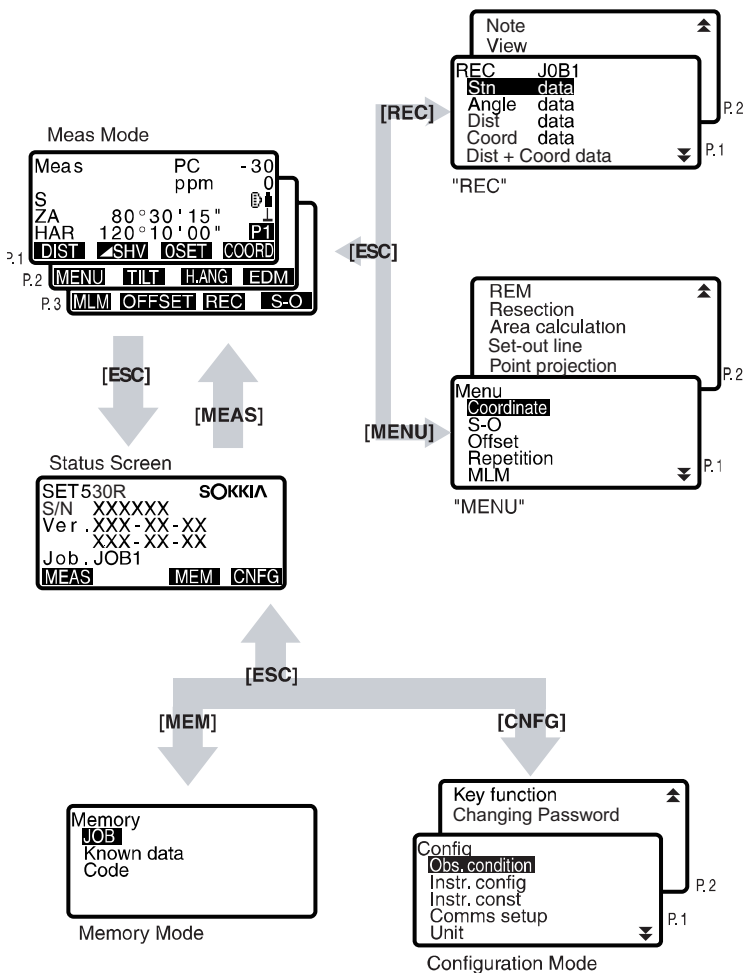

5. BASIC OPERATION

5.1 Basic Key Operation

Learn basic key operations here before you read each measurement procedure.

 Location of operation keys on the panel and Location of operation keys on the wireless keyboard : "4.1 Parts of the Instrument"

- Wireless keyboard (SF14) (Optional accessory) makes key operation easier and speedier.

 Specification of the keyboard: "27.2 Optional Accessories"

● Power ON / OFF

{ON} : Power On

{ON} (while pressing) +  : Power Off

● Lighting up the display

 : Switch the screen backlight On / Off

● Switching target type

Target type can be switched only on the screen where the target symbol (ex. ) is displayed.

{SFT} : Switches between target types (Prism/Sheet/None(reflectorless))

 Target symbol displayed: "5.2 Display Functions", Switching the target type in Config mode": "24.1 Changing Instrument Options, ● EDM setting"

● Switching the Laser-pointer /Guide light (optional function) ON / OFF

 (Press and hold) : To turn the Laser-pointer / Guide light ON/OFF, press and hold until a beep sounds.

 Selecting of laser-pointer / guide light (optional function) : "24.1 Changing Instrument Options, ● EDM setting"



- After turning ON the Laser-pointer / Guide light, the laser beam is emitted for 5 minutes, and then automatically switches OFF. But in the Status screen and when target symbol (ex. ) is not displayed in the Meas mode, the laser beam is not automatically turned off.

● Softkey operation

Softkeys are displayed on the bottom line of the screen.

{F1} to {F4}: Select the function matching the softkeys

{FUNC} : Toggle between Meas mode screen pages (when more than 4 softkeys are allocated)

5. BASIC OPERATION

● Inputting letters / figures

- {F1}** to **{F4}**: Input a letter or a figure allocated to the softkey
{FUNC} : Go to the next softkey page (search for the letter or figure you want to input)
{FUNC} (hold for a moment): Go back one softkey page
{FUNC} (continue to hold): Go to previous softkey pages
{BS} : Delete a character on the left
{ESC} : Cancel the input data
{SFT} : Switch between upper and lower case
{←} : Select / accept input word / value

Example: Input of angle 125° 30' 00"(Input "125.3000")

1. Press **[H.ANG]** in page 2 of Meas mode.
2. Press **{←}** to select "H angle."
3. Press **[1]**. "1" is input and the cursor moves to next input position.
4. Press **[2]**.
5. Press **{FUNC}** to display the page in which **[5]** is allocated.
6. Press **[5]**.
7. Press **{FUNC}** to display the page in which **[.]** is allocated.
8. Input the remaining figures. When input is complete, press **{←}** to accept the value.

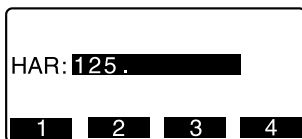

- When inputting alphabetic characters, press **{FUNC}** until the page in which letters are allocated is displayed, and input using the same procedure used for inputting figures.

● Selecting options

- {▲}** / **{▼}** : Up and down cursor
{▶} / **{◀}** : Right and left cursor / Select other option
{←} : Accept the option

Example: Select a reflector type

1. Press **[EDM]** in page 2 of Meas mode.
2. Move to "Reflector" using **{▲}** / **{▼}**.
3. Display the option you want to select using **{▶}** / **{◀}**.
Switches between "Sheet", "Prism" and "None."

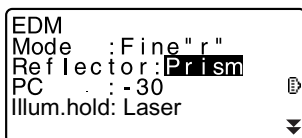

4. Press {←} or {▼} to move to the next option.
The selection is set and you can set the next item.

● Switching modes

[CNFG] : From Status mode to Config Mode (Configuration Mode)

[MEAS] : From Status mode to Meas Mode (Measurement Mode)

[MEM] : From Status mode to Memory Mode

{ESC} : Return to the Status mode from each Mode

 "4.2 Mode Diagram"

● Other operation

{ESC} : Return to the previous screen

5. BASIC OPERATION

Key operation for Wireless Keyboard (SF14)

The SET is operated from the Wireless Keyboard by pointing the Wireless Keyboard beam at the Beam Detector on the SET and pressing the required operation keys.

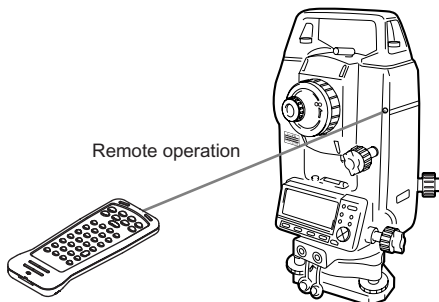

Caution

- When sunlight shines directly into the Beam Detector on the SET, the Wireless Keyboard may not work correctly.
- If other SETs are turned ON and placed within the operating range of the Wireless Keyboard, they may be unintentionally operated at the same time.
- Do not place the keyboard under heavy objects or in a tight space. A key may be continuously depressed and deplete battery power.
- Ni-Cd batteries are recommended when operating the Wireless Keyboard under low temperatures.
- In temperatures around -20°C , the SET may function erratically if the Wireless Keyboard is operated too close to the SET. Hold the Wireless Keyboard further away from the SET and at various angles to the Beam Detector until normal operation is resumed.

● Measuring distance

{MEAS} : Start distance measurement (same as pressing **[DIST]** or **[OBS]** on the screen / same as pressing **[MLM]** in missing line measurement) / Stop distance measurement

● Inputting letters / figures

{A/N} : Switch between numerals and alphabetic characters
{A} to {Z} : During numeric input, input numeral or symbol (+/- and .) printed above the key
During alphabetic input, input the character of the key

- {E} : Enter letters and figures editing mode (same as pressing [EDIT] on the screen)
- {BS} : Delete a character on the left
- {ESC} : Cancel the input data
- {SFT} : Switch between upper and lower case
- {←} : Select / accept input word / value

● **Selecting options**

- {R} / {U} (▲/▼ is printed above the key) : Up and down cursor (numeric input mode)
- {V} / {T} (▶/◀ is printed above the key) : Right and left cursor / Select other option (numeric input mode)
- {←} : Accept the option



- Other operations (softkey operations and switching modes) are the same for the operation panel on the SET.
- Power On/Off, lighting up the display, Laser-pointer and Guide light (optional function) On/Off cannot be done on the Wireless Keyboard.

5.2 Display Functions

Status screen

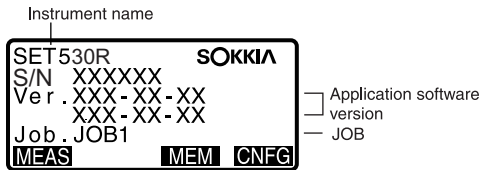

Meas Mode screen

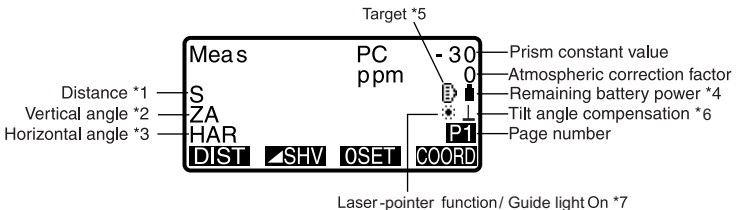

5. BASIC OPERATION

Measuring screen

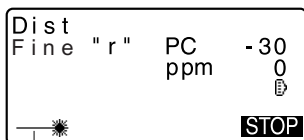

Laser is emitted *8

Input screen



* 1 Distance

Switching distance display status: "24.1 Changing Instrument Options ● Settings in Config Mode"

S : Slope distance

H : Horizontal distance

V : Height difference

* 2 Vertical angle

Switching vertical angle display status: "24.1 Changing Instrument Options ● Settings in Config Mode"

ZA : Zenith angle (Z=0)

VA : Vertical angle (H=0 / H=±90)

To switch vertical angle/slope in %, press **[ZA/%]**

* 3 Horizontal angle

Press **[R/L]** to switch the display status.

HAR: Horizontal angle right

HAL: Horizontal angle left

* 1,2,3

To switch usual "S, ZA, H" display to "S, H, V", press **[▲SHV]**.

* 4 Remaining battery power (BDC46A, Temperature=25°C, EDM on)

: level 3 Full power.

: level 2 Plenty of power remains.

: level 1 Half or less power remains.

: level 0 Little power remains. Charge the battery.

 (This symbol is displayed every 3 seconds): No power remains.
Stop the measurement and charge the battery.

 "6.1 Battery Charging"

*5 Target display

Press **{SFT}** to switch the selected target. This key function can be used only on the screens on which the target symbol is displayed.

 :prism

 :reflective sheet

 :reflectorless

*6 Tilt angle compensation

When this symbol is displayed, the vertical and horizontal angles are automatically compensated for small tilt errors using 2-axis tilt sensor.

 Tilt compensation setting: "24.1 Changing Instrument Options ● Settings in Config Mode"

*7 Laser-pointer/Guide light (optional function) display

 Selecting Laser-pointer/Guide light: "24.1 Changing Instrument Options ● EDM settings", Switching Laser-pointer/Guide light ON/OFF : "5.1 Basic Key Operation"

 :Laser-pointer is selected and ON

 :Guide light is selected and ON

*8 Appears when laser beam is emitted for distance measurement

*9 Input mode

 :Inputting capital letters and figures.

 :Inputting small letters and figures.

6. USING THE BATTERY

6.1 Battery Charging

The battery has not been charged at the factory.

Caution

- Do not short circuit. Heat or ignition could result.
- Batteries cannot be charged, even when the charging lamp is flashing, when the temperature is outside the charging temperature range. Do charge batteries within the charging temperature range.
- Do not leave the battery in places exposed to high temperatures (more than 35°C). Doing so may reduce the life of the battery.
- Charge the battery once a month to maintain its quality when not in use for long periods.
- Do not charge the battery just after charging is completed. Battery performance may decline.
- Do not use to charge batteries other than those specified.
- If you allow the battery level to get too low, the battery may not be rechargeable or operating time may decline. Keep the battery always charged.
- The charger will become rather hot during use. This is normal.

► PROCEDURE

1. Connect the power cable to the CDC68 charger and plug the charger into the wall outlet .
2. Mount the battery (BDC46A) in the charger (CDC68) by matching the grooves on the battery with the guides on the charger. When charging starts, the lamp starts blinking.
3. Charging takes approximately 2 hours (25°C). The lamp lights when charging is finished.
4. Remove the battery and unplug the charger.

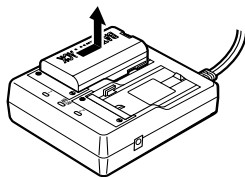
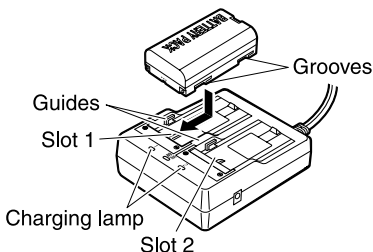



- Slots 1 and 2: The charger starts charging the battery mounted first. If you place two batteries in the charger, the battery in slot 1 is charged first, and then the battery in slot 2. (step 2)
- Charging lamp: The charging lamp is off when the charger is outside the charging temperature range or when the battery is mounted incorrectly. If the lamp is still off after the charger falls within its charging temperature range and the battery is mounted again, contact your Sokkia agent. (steps 2 and 3)
- Charging time : Charging can take more than 2 hours when temperatures are either especially high or low.

6.2 Installing / Removing the Battery

Mount the charged battery.

Caution

- When removing the battery, turn the power off.
- When installing / removing the battery, make sure that moisture or dust particles do not come in contact with the inside of the instrument.

►PROCEDURE

1.

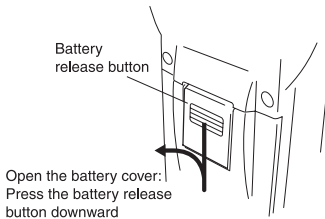

6. USING THE BATTERY

2.

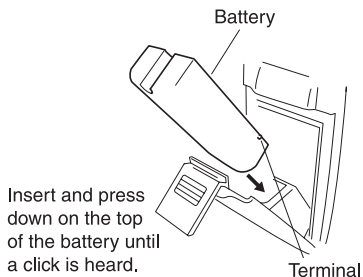

3.

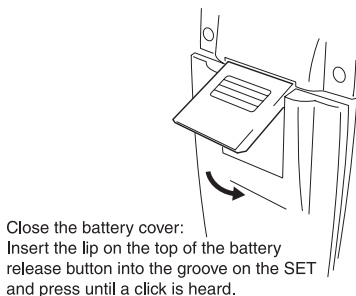

Note

- Battery cover

If the battery cover is open during power on, SET notifies you by displaying the screen below and beeping.

When the battery cover is closed, the previous screen is restored.

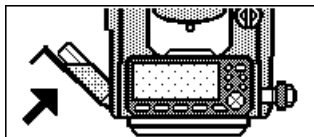

7. SETTING UP THE INSTRUMENT

Caution

- Mount the battery in the instrument before performing this operation because the instrument will tilt slightly if the battery is mounted after levelling.

7.1 Centering

► PROCEDURE

- Set up the tripod
Make sure the legs are spaced at equal intervals and the head is approximately level.
Set the tripod so that the head is positioned over the surveying point.
Make sure the tripod shoes are firmly fixed in the ground.

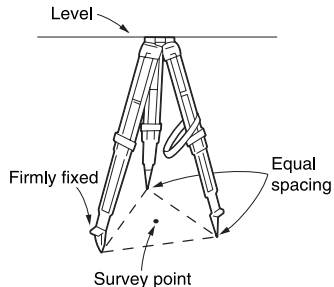

- Install the instrument
Place the instrument on the tripod head.
Supporting it with one hand, tighten the centering screw on the bottom of the unit to make sure it is secured to the tripod.

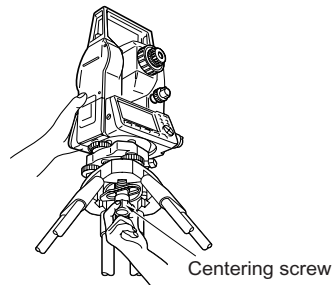

- Focus on the surveying point
Looking through the optical plummet eyepiece, turn the optical plummet eyepiece to focus on the reticle.
Turn the optical plummet focusing ring to focus on the surveying point.

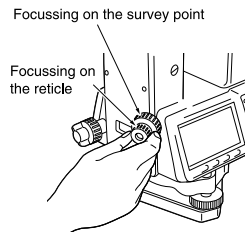

7. SETTING UP THE INSTRUMENT

7.2 Levelling

Instrument can be levelled using the screen.

 "Note" Levelling on the screen"

► PROCEDURE

1. Center the surveying point in the reticle
Adjust the levelling foot screws to center the surveying point in the optical plummet reticle.

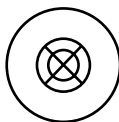

2. Center the bubble in the circular level
Center the bubble in the circular level by either shortening the tripod leg closest to the offcenter direction of the bubble or by lengthening the tripod leg farthest from the offcenter direction of the bubble. Adjust one more tripod leg to center the bubble.

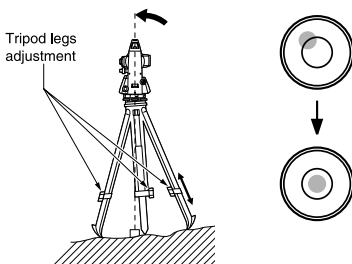

3. Center the bubble in the plate level
Loosen the horizontal clamp to turn the upper part of the instrument until the plate level is parallel to a line between levelling foot screws A and B.
Center the air bubble using levelling foot screws A and B. The bubble moves towards a clockwise rotated levelling foot screw.

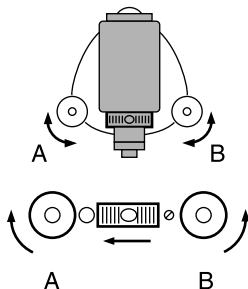

7. SETTING UP THE INSTRUMENT

4. Turn 90° and center the bubble
Turn the upper part of the instrument through 90° .
The plate level is now perpendicular to a line between levelling foot screws A and B.
Center the air bubble using levelling foot screw C.

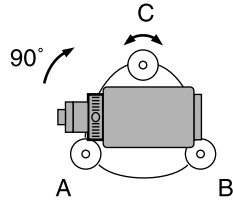

5. Turn another 90° and check bubble position
Turn the upper part of the instrument a further 90° and check to see if the bubble is still in the center of the plate level. If the bubble is off-center, perform the following:

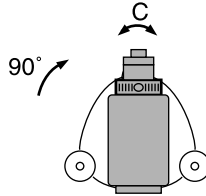

- Turn levelling foot screws A and B equally in opposite directions to remove half of the bubble displacement.
- Turn the upper part a further 90° , and use levelling foot screw C to remove half of the displacement in this direction.

Or adjust the plate level.

 "26.1 Plate Level"

6. Check to see if the bubble is in the same position in any direction
Turn the instrument and check to see if the air bubble is in the same position in all directions.
If it is not, repeat the levelling procedure.

7. SETTING UP THE INSTRUMENT

7. Center the SET over the
Surveying point
Loosen the centering screw
slightly.
Looking through the optical
plummet eyepiece, slide the
instrument over the tripod head
until the surveying point is exactly
centered in the reticle.
Retighten the centering screw
securely.

8. Check again to make sure the
bubble in the plate level is
centered
If not, repeat the procedure starting
from step 3.

►PROCEDURE Levelling on the screen

1. Press **{ON}** to power on
2. Press **[TILT]** in the second page of Meas Mode to display the circular level on the screen.
 "●" indicates bubble in circular level. The range of the inside circle is $\pm 3'$ and the range of the outside circle is $\pm 6'$.
 Tilt angle values X and Y are also displayed on the screen.

3. Center "●" in the circular level
 "7.2 Levelling" steps 1 to 2

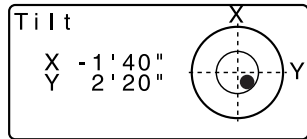

4. Turn the instrument until the telescope is parallel to a line between levelling foot screws A and B, then tighten the horizontal clamp.
5. Set the tilt angle to 0° using foot screws A and B for the X direction and levelling screw C for the Y direction.
6. Press **{ESC}** to return to Meas Mode.

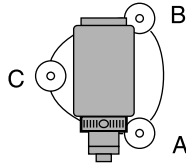

8. FOCUSING AND TARGET SIGHTING

Caution

- When sighting the target, strong light shining directly into the objective lens may cause the instrument to malfunction. Protect the objective lens from direct light by attaching the lens hood.
Observe to the same point of the reticle when the telescope face is changed.

► PROCEDURE

1. Focus on the reticle
Look through the telescope eyepiece at a bright and featureless background.
Turn the eyepiece screw clockwise, then counterclockwise little by little until just before the reticle image becomes focussed.
Using these procedures, frequent reticle refocussing is not necessary since your eye is focussed at infinity.
2. Sight the target
Loosen the vertical and horizontal clamps, then use the peep sight to bring the target into the field of view. Tighten both clamps.
3. Focus on the target
Turn the telescope focussing ring to focus on the target.
Turn the vertical and horizontal fine motion screws to align the target with the reticle.
The last adjustment of each fine motion screw should be in the clockwise direction.

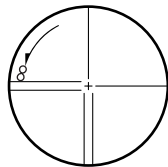

4. Readjust the focus until there is no parallax
Readjust the focus with the focussing ring until there is no parallax between the target image and the reticle.



Eliminating parallax

This is the relative displacement of the target image with respect to the reticle when the observer's head is moved slightly before the eyepiece. Parallax will introduce reading errors and must be removed before observations are taken. Parallax can be removed by refocussing the reticle.

9. POWER ON

Setting "V manual": "24.1 Changing Instrument Options • Settings in Config Mode", Setting / changing password: "24.3 Changing Password"

►PROCEDURE

1. Power on

Press **{ON}**.

When the power is switched on, a self-check is run to make sure the instrument is operating normally.

- When password is set, the display appears as at right. Input password and press **{←}**.

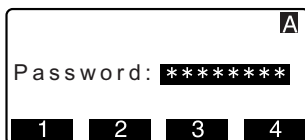

- When "V manual" is set to "Yes", the display appears as at right.

Manually indexing the vertical circle by face left, face right measurements:
"30. EXPLANATION"

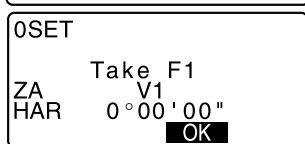

After that, Meas Mode screen appears.

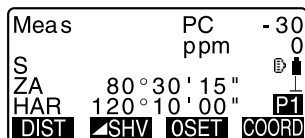

If "Out of range" is displayed, the instrument tilt sensor is indicating that the instrument is out of level. Level the instrument once again and the horizontal and vertical angles will be displayed.

Note

- When "Resume" in "Instr. config" is set to "On", the screen previous to power off is displayed.

"24.1 Changing Instrument Options • Settings in Config Mode"

- "Tilt crn" in "Obs. condition" should be set to "No" if the display is unsteady due to vibration or strong wind.

"24.1 Changing Instrument Options • Settings in Config Mode"

10. ANGLE MEASUREMENT

This section explains the procedures for basic angle measurement.

10.1 Measuring the Horizontal Angle between Two Points (Horizontal Angle 0°)

Use the "0SET" function to measure the included angle between two points. The horizontal angle can be set to 0 at any direction.

► PROCEDURE

1. Sight the first target as at right.

1st target

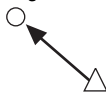

Instrument Station

2. In the first page of the Meas mode screen, press [0SET].

[0SET] will flash, so press [0SET] again.

The horizontal angle at the first target becomes 0°.

Meas	PC	-30
	ppm	0
ZA	89°59'50"	↓
HAR	0°00'00"	P1
DIST	SHV	0SET
		COORD

3. Sight the second target.

2nd Target



The displayed horizontal angle (HAR) is the included angle between two points.

Meas	PC	-30
	ppm	0
ZA	89°59'50"	↓
HAR	117°32'20"	P1
DIST	SHV	0SET
		COORD

10.2 Setting the Horizontal Angle to a Required Value (Horizontal Angle Hold)

You can reset the horizontal angle to a required value and use this value to find the horizontal angle of a new target.

► PROCEDURE

1. Sight the first target.
2. In the second page of the Meas mode screen, press **[H.ANG]**. Select "H angle."
3. Enter the angle you wish to set, then press **{←}**. The value that is input as the horizontal angle is displayed.

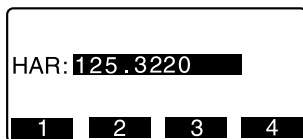

4. Sight the second target. The horizontal angle from the second target to the value set as the horizontal angle is displayed.

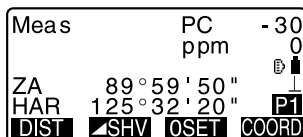

Note

- Pressing **[HOLD]** performs the same function as above.
- Press **[HOLD]** to set the displayed horizontal angle. Then, set the angle that is in hold status to the direction you require.
 Allocating **[HOLD]**: "24.2 Allocating Key Functions"

10.3 Horizontal Angle Repetition

To find the horizontal angle with greater precision, perform repetition measurement.

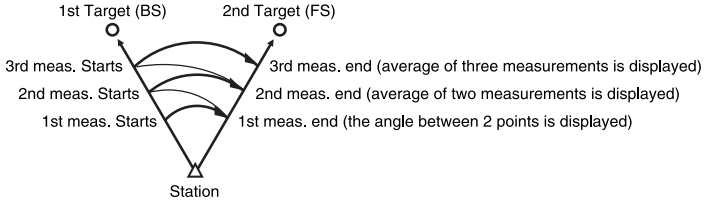

- The maximum number of angle measurements that can be made is 10.

► PROCEDURE

1. In the second page of Meas mode screen, press **[MENU]**, then select "Repetition".
2. Sighting the first target, press **[OK]**.
3. Sighting the second target, press **[OK]**.
4. Sighting the first target a second time, press **[OK]**.
5. Sighting the second target a second time, press **[OK]**.
The added value of the horizontal angle is displayed on the second line "HARp" and the average value of the horizontal angle is displayed on the fourth line "Ave.".

```
Menu
Coordinate
S-O
Offset
Repetition
MLM
```

```
Repetition
HARp 0°00'00"
Reps. 0
Ave. 0°00'00"
Take BS
CE OK
```

```
Repetition
HARp 110°16'20"
Reps. 2
Ave. 50°38'10"
Take BS
CE OK
```

10. ANGLE MEASUREMENT

- Return to the previous measurement of the first target and redo it: **[CE]**.
(Effective when the display shows "Take BS")
6. When continuing the repetition measurement, repeat steps 4 to 5.
 7. When the repetition measurement is completed, press **{ESC}**.

Note

- It is also possible to perform repetition measurement when **[REP]** on Meas mode screen.
 Allocating **[REP]**: "24.2 Allocating Key Functions"

10.4 Angle Measurement and Outputting the Data

The following explains angle measurement and the features used to output measurement data to a computer or peripheral equipment.

 Communication cables: "27.2 Optional Accessories"

Output format and command operations: "Interfacing with the SOKKIA SDR Electronic Field Book" and "Command Explanations" manuals.

► PROCEDURE

1. Connect SET and host computer.
2. Allocate the **[D-OUT]** softkey to the Meas mode screen.
 "24.2 Allocating Key Functions"
3. Sight the target point.
4. Press **[D-OUT]** and select "Angle Data."
Output measurement data to peripheral equipment.

11. DISTANCE MEASUREMENT

Perform the following settings as preparation for distance measurement.

- Distance measurement mode
- Target type
- Prism constant correction value
- Atmospheric correction factor
- EDM ALC

 "24.1 Changing Instrument Options ● EDM Settings / ● Settings in Config Mode"

CAUTION

- When using the Laser-pointer function, be sure to turn OFF the output laser after distance measurement is completed. Even if distance measurement is canceled, the Laser-pointer function is still operating and the laser beam continues to be emitted. (After turning ON the Laser-pointer, the laser beam is emitted for 5 minutes, and then automatically switches OFF. But in the Status screen and when target symbol (ex. ) is not displayed in the Meas mode, the laser beam is not automatically turned off.)

Caution

- Make sure that the target setting on the instrument matches the type of target used. SET automatically adjusts the intensity of the laser beam and switches the distance measurement display range to match the type of target used. If the target does not correspond to the target settings, accurate measurement results cannot be obtained.
- Accurate measurement results cannot be obtained if the objective lens is dirty. Dust it off with the lens brush first, to remove minute particles. Then, after providing a little condensation by breathing on the lens, wipe it off with the wiping cloth.
- During reflectorless measurement, if an object with a high reflective factor (metal or white surface) is positioned between the SET and the target, accurate measurement results may not be received.
- Scintillation may affect the accuracy of distance of measurement results. Should this occur, repeat measurement several times and use the averaged value of the obtained results.

11.1 Returned Signal Checking

- Check to make sure that sufficient reflected light is returned by the reflective prism sighted by the telescope. Checking the returned signal is particularly useful when performing long distance measurements.

Caution

- When the light intensity is sufficient even though the center of the reflective prism and the reticle are slightly misaligned (short distance etc.), “**” will be displayed in some cases, but in fact, accurate measurement is impossible. Therefore make sure that the target center is sighted correctly.

► PROCEDURE

1. Allocate the **[AIM]** softkey to the Meas mode screen.

 "24.2 Allocating Key Functions"

2. Accurately sight the target.

3. Press **[AIM]**.

<Aiming> is displayed.

The intensity of the light of the returned signal is displayed by a gauge.

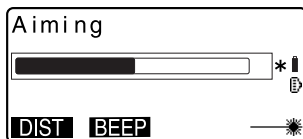

- The more  displayed, the greater the quantity of reflected light.
- If “**” is displayed, only enough light for the measurement is returned.
- When “**” is not displayed, accurately resight the target. Press **[BEEP]** to make a buzzer sound when measurement is possible. Press **[OFF]** to shut off the buzzer.
- Press **[DIST]** to shift distance measurement.

- Press **{ESC}** to finish signal checking and return to Meas Mode.



- When ████████ is displayed persistently, contact your Sokkia agent.
- If no key operations are performed for two minutes, the display automatically returns to the Meas mode screen.

11.2 Distance and Angle Measurement

An angle can be measured at the same time as the distance.

►PROCEDURE

- Sight the target.
- In the first page of Meas Mode, press **[DIST]** to start distance measurement.

Meas	PC	-30
	ppm	0
S		
ZA	80°30'15"	
HAR	120°10'00"	P1
[DIST]	[SHV]	[OSET] [COORD]

When measurement starts, EDM information (distance mode, prism constant correction value, atmospheric correction factor) is represented by a flashing light.

Dist	PC	-30
Fine " r "	ppm	0
		[STOP]



A short beep sounds, and the measured distance data (S), vertical angle (ZA), and horizontal angle (HAR) are displayed.

Meas	PC	-30
	ppm	0
S	525.450m	
ZA	80°30'10"	
HAR	120°10'00"	P1
		[STOP]

11. DISTANCE MEASUREMENT

3. Press **[STOP]** to quit distance measurement.

- Each time **[ SHV]** is pressed, S (Slope distance), H (Horizontal distance) and V (Height difference) are displayed alternately.

Meas	PC	- 30
	ppm	0
S	525.450m	
H	518.248m	
V	86.699m	P1
DIST	 SHV	OSET COORD

Note

- If the single measurement mode is selected, measurement automatically stops after a single measurement.
- During fine average measurement, the distance data is displayed as S-1, S-2, ... to S-9. When the designated number of measurements has been completed, the average value of the distance is displayed in the [S-A] line.
- The distance and angle that are most recently measured remain stored in the memory until the power is off and can be displayed at any time.
 "11.3 Recalling the Measured Data"

11.3 Recalling the Measured Data

The distance and angle that are most recently measured remain stored in the memory until the power is off and can be displayed at any time.

The distance measurement value, vertical angle, horizontal angle, and the coordinates can be displayed. Distance measurement values converted into the horizontal distance, elevation difference, and the slope distance can also be displayed.

► PROCEDURE

1. Allocate the **[RCL]** softkey to the Meas mode screen.
 "24.2 Allocating Key Functions"

2. Press **[RCL]**.
The stored data that is most recently measured is displayed.

S	525.450m
ZA	80°30'10"
HAR	120°10'10"
N	-128.045
E	-226.237
Z	30.223

- If you have pressed **[SHV]** beforehand, the distance values are converted into the horizontal distance, elevation difference, and the slope distance and recalled.

3. Press **{ESC}** to return to Meas mode.

11.4 Distance Measurement and Outputting the Data

The following explains distance measurement and the features used to output measurement data to a computer or peripheral equipment.

 Communication cables: "27.2 Optional Accessories"

Output format and command operations: "Interfacing with the SOKKIA SDR Electronic Field Book" and "Command Explanations" manuals.

► PROCEDURE

1. Connect SET and host computer.
2. Allocate the **[D-OUT]** softkey to the Meas mode screen.
 "24.2 Allocating Key Functions"
3. Sight the target point.
4. Press **[D-OUT]**, and select "Dist data" to measure the distance and output the data to peripheral equipment.
5. Press **[STOP]** to stop outputting data and return to Meas Mode.

11. DISTANCE MEASUREMENT

11.5 REM Measurement

An REM measurement is a function used to measure the height to a point where a target cannot be directly installed such as power lines, overhead cables and bridges, etc.

The height of the target is calculated using the following formula.

$$H_t = h_1 + h_2$$

$$h_2 = S \sin \theta_{z1} \times \cot \theta_{z2} - S \cos \theta_{z1}$$

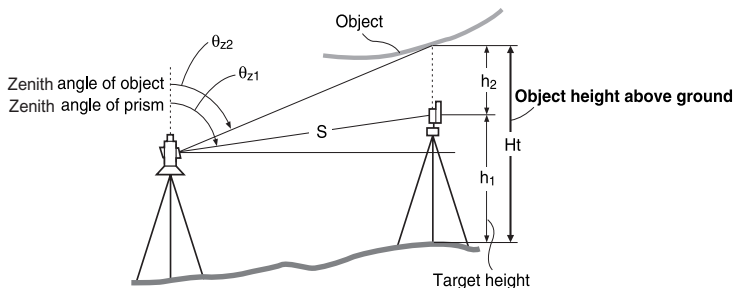

► PROCEDURE

1. Set the target directly under or directly over the object and measure the target height with a tape measure etc.

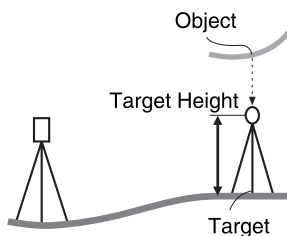

2. After inputting the target height, accurately sight the target.
 "Note"
Press **[DIST]** in page 1 of Meas Mode to carry out measurement.

The measured distance data (S), vertical angle (ZA), and horizontal angle (HAR) are displayed.

Press **[STOP]** to stop the measurement.

3. In the second page of Meas mode screen, press **[MENU]**, then select "REM".

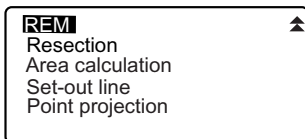

4. The REM measurement is started and the height from the ground to the object is displayed in "Ht.".

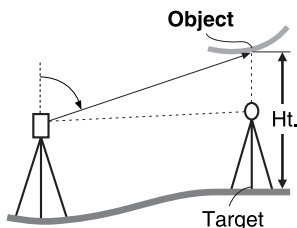
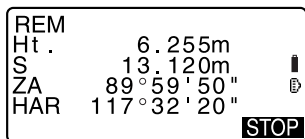

5. Press **[STOP]** to terminate the measurement operation.

- To re-observe the target, sight the target, then press **[OBS]**.

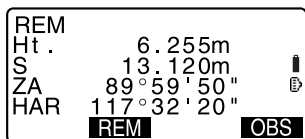

6. Press **{ESC}** to finish measurement and return to the Meas mode screen.



- It is also possible to perform REM measurement when **[REM]** on the Meas mode screen.
 - "24.2 Allocating Key Functions"
- Inputting target height (Step 3): Press **[HT]** to set target height. It can be set also in "Stn data" of coordinate measurement.
 - "12.1 Entering Instrument Station Data"

12. COORDINATE MEASUREMENT

By performing coordinate measurements it is possible to find the 3-dimensional coordinates of the target based on station point coordinates, instrument height, target height, and azimuth angles of the backsight station which are entered in advance.

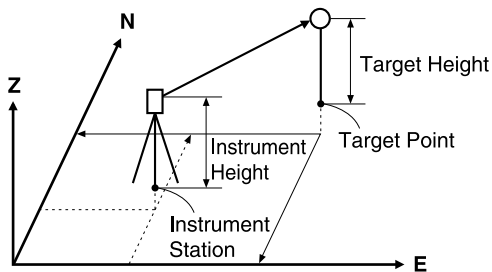

- EDM setting can be done in coordinate measurement menu.
☞ Setting items: “24.1 Changing Instrument Options ● EDM settings”

12.1 Entering Instrument Station Data

Before coordinate measurement, enter instrument station coordinates, the instrument height, and target height.

► PROCEDURE

1. First measure the target height and instrument height with a tape measure, etc.
2. Press **[COORD]** in the first page of the Meas mode screen to display <Coord.>

3. Select "Stn Orientation," then "Stn coordinate."
Press **[EDIT]**, then input the instrument station coordinates, instrument height and target height.

N0:	0.000
E0:	0.000
Z0:	0.000
Inst.h:	1.400m
Tgt.h:	1.200m
READ	REC
EDIT	OK

N0:	370.000
E0:	10.000
Z0:	100.000
Inst.h:	1.400m
Tgt.h:	1.200m
1	2
3	4

- When you wish to read in the registered coordinate data, press **[READ]**.

 "PROCEDURE Reading in Registered Coordinate Data"

4. Press **[OK]** to set the input values.
<Coord> is displayed again.

- When **[REC]** is pressed, instrument station data is saved.

 "20. RECORDING DATA - RECORD MENU -"

12. COORDINATE MEASUREMENT

►PROCEDURE Reading in Registered Coordinate Data

Known point data, coordinate data and instrument station data in the current JOB and Coordinate Search JOB can be read in.

Confirm that the correct JOB containing the coordinates you want to read in is already selected in Coordinate Search JOB in Memory Mode.

☞ "22.1 Registering/Deleting Known Point Data", "21.1 Selecting a JOB"

1. Press **[READ]** when setting Instrument Station.
The list of registered coordinates is displayed.

Pt. : Known point data saved in the current JOB or in the Coordinate Search JOB.

Crd./ Stn : Coordinate data saved in the current JOB or in the Coordinate Search JOB.

Pt.	11111111	▲	
Pt.	1		
Crd.	2		
Stn	12345679		
Stn	1234	▼	
[↑↓...P]	[TOP]	[LAST]	[SRCH]

2. Align the cursor with the required point number and press **{←}**.
The point number that was read in and its coordinate is displayed.

NO:	9.876		
E0:	5.432		
Pt.	PNT-001		
Inst.h	0.000 m		
Tgt.h	0.000 m		
[READ]	[REC]	[EDIT]	[OK]

- **[↑↓...P]** = Use **{▲}** / **{▼}** to move from page to page.
- **[↑↓...P]** = Use **{▲}** / **{▼}** to select individual point.
- Press **[TOP]** to move to the first point number on the first page.
- Press **[LAST]** to move to the last point number on the last page.
- Press **[SRCH]** to move to the "Coordinate Data Search Screen." Input the point number you want to search in "Pt. no." The search may take time if many data are registered.

3. Press **[OK]**.
<Instrument Station Data Setting>
is restored.
 - Press **[EDIT]** to edit the coordinate data that was read in. Editing does not affect the original coordinate data. After editing, the point number is no longer displayed.



- The point number that was read in is displayed until the current JOB is changed.
- When **[SRCH]** is pressed, SET searches data in the current JOB first, then in the Coordinate Search JOB.
- If more than two points with the same point name exist in the current JOB, SET finds the newer data only.

12.2 Azimuth Angle Setting

Based on the instrument station coordinates and backsight station coordinates which have already been set, the azimuth angle of the backsight station is calculated.

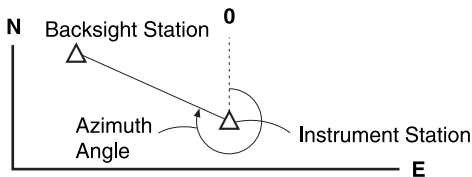

► PROCEDURE

1. Select "Stn.Orientation", then "Set H angle" in <Coord.>.

12. COORDINATE MEASUREMENT

2. Select "Back sight", press **[EDIT]**, then input the backsight station coordinates.
 - When you wish to read in and set coordinate data from memory, press **[READ]**.
- ☞ "12.1 Entering Instrument Station Data,PROCEDURE Reading in Registered Coordinate Data"
3. Press **[OK]**. Instrument station coordinates are displayed.
4. Press **[OK]** again to set the instrument coordinates.
5. Sight the backsight station, then press **[YES]** to set the backsight station.
<Coord> is restored.
 - Press **[NO]** to go back to step 2.

Set H angle/BS			
NBS:		170.000	
EBS:		470.000	
ZBS:		100.000	
1	2	3	4

Set H angle	
Take BS	
ZA	89°59'55"
HAR	117°32'20"
	[NO] [YES]

12.3 3-D Coordinate Measurement

The coordinate values of the target can be found by measuring the target based on the settings of the instrument station and backsight station.

The coordinate values of the target are calculated using the following formulae.

$$N1 \text{ Coordinate} = N0 + S \times \sin Z \times \cos Az$$

$$E1 \text{ Coordinate} = E0 + S \times \sin Z \times \sin Az$$

$$Z1 \text{ Coordinate} = Z0 + S \times \cos Z + ih - fh$$

N0: Station point N coordinate S: Slope distance ih: Instrument height

E0: Station point E coordinate Z: Zenith angle fh: Target height

Z0: Station point Z coordinate Az: Direction angle

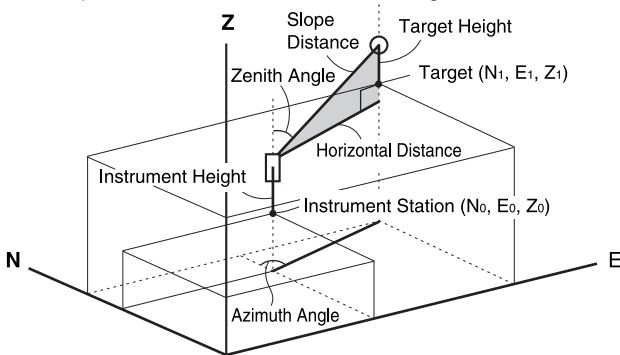



► PROCEDURE

1. Sight the target at the target point.
2. In <Coord>, select "Observation" to start measurement. The coordinate value of the target is displayed. Press **[STOP]** to quit measurement.

```
Coord.
Stn. Orientation
Observation
EDM
```

12. COORDINATE MEASUREMENT

- By pressing **[HT]**, the instrument station data can be reset. When the target height of the next target is different, reenter the target height before beginning the observation.

N	240.490	
E	340.550	
Z	305.740	
ZA	89°42'50"	
HAR	180°31'20"	
OBS	HT	REC

- **[REC]**: records measurement results



Recording method:

"20. RECORDING DATA -
RECORD MENU -"

3. Sight the next target and press **[OBS]** to begin measurement. Continue until all targets have been measured.
4. When coordinate measurement is completed, press **{ESC}** to return to <Coord>.

13. RESECTION MEASUREMENT

Resection is used to determine the coordinates of an instrument station by performing multiple measurements of points whose coordinate values are known. Registered coordinate data can be recalled and set as known point data. Residual of each point can be checked, if necessary.

Entry

Output

Coordinates of known point : (X_i, Y_i, Z_i) Station point coordinates : (X_0, Y_0, Z_0)

Observed horizontal angle : H_i

Observed vertical angle : V_i

Observed distance : D_i

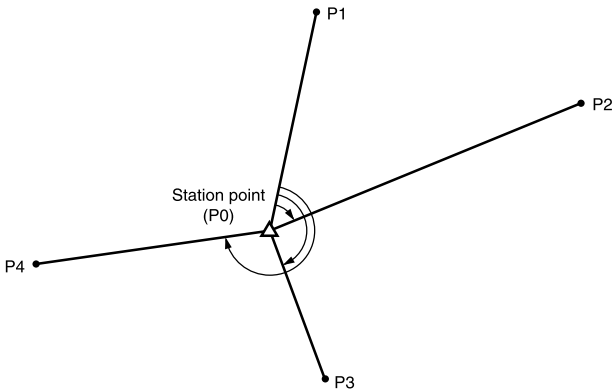

- All the N, E, Z or only Z data of an instrument station is calculated by measuring the known points.
- Coordinate resection measurement overwrites the N, E and Z data of the instrument station, but height resection does not overwrite N and E. Always perform resection measurement in the sequence described in "13.1 Coordinate Resection Measurement" and "13.2 Height Resection Measurement".
- Input known coordinate data and calculated instrument station data can be recorded in the current JOB.

 "21. SELECTING / DELETING A JOB"

13. RESECTION MEASUREMENT

13.1 Coordinate Resection Measurement

N, E, Z of an instrument station is determined by the measurement.

- Between 2 and 10 known points can be measured by distance measurement, and between 3 and 10 known points by angle measurement.

► PROCEDURE

1. In the second page of Meas mode screen, press **[MENU]**, then select "Resection".

```
REM
Resection
Area calculation
Set-out line
Point projection
```

2. Select "NEZ" and press **[EDIT]** to input the known point.
After setting the coordinates for the first known point press **[▶]** to move to the second point.
When all required known points have been set, press **[MEAS]**.

```
Resection.
NEZ
Elevation
```

- When **[READ]** is pressed, registered coordinates can be recalled and used.

```
2nd Pt.
Np : 100.000
Ep : 100.000
Zp : 50.000
Tgt.h : 1.400m
READ REC EDIT MEAS
```

 "12.1 Entering Instrument Station Data, PROCEDURE Reading in Registered Coordinate Data"

3. Sight the first known point and press **[DIST]** to begin measurement.
The measurement results are displayed on the screen.
- When **[ANGLE]** has been selected, the distance cannot be displayed.

```
Resection 1st Pt.
N 100.000
E 100.000
Z 50.000
DIST ANGLE
```

13. RESECTION MEASUREMENT

4. Press **[YES]** to use the measurement results of the first known point.

- You can also input target height here.

Resection	1st Pt.
S	525.450m
ZA	80°30'15"
HAR	120°10'00"
Tgt.h	1.400m
EDIT	NO YES

5. Repeat procedures 4 to 5 in the same way from the second point. When the minimum quantity of observation data required for the calculation is present, **[CALC]** is displayed.

6. Press **[CALC]** or **[YES]** to automatically start calculations after observations of all known points are completed. Instrument station coordinate and standard deviation, which describes the measurement accuracy, are displayed.

Resection	3rd Pt.
S	125.450m
ZA	40°30'15"
HAR	20°10'00"
Tgt.h	1.200m
CALC	EDIT NO YES

7. Press **[RESULT]** to check the result.
If there are no problems with the result, press **{ESC}** and go to step 11.

N	100.001
E	100.000
Z	9.999
σ N	0.0014m
σ E	0.0007m
RESULT	REC OK

- **[REC]**: records measurement results

 Recording method:
"20. RECORDING DATA -
RECORD MENU -"

- Press **[ADD]** when there is a known point that has not been measured or when a new known point is added.

	σ N	σ E
1st	-0.001	0.001
* 2nd	0.005	0.010
3rd	-0.001	0.001
4th	-0.003	-0.002
BAD	RE_CALC	RE_OBS ADD

13. RESECTION MEASUREMENT

8. If there are problems with the results of a point, align the cursor with that point and press **[BAD]**. “*” is displayed on the left of the point. Repeat for all results that include problems.

9. Press **[RE CALC]** to perform calculation again without the point designated in step 8. The result is displayed.

If there are no problems with the result, go to step 10.

If problems with the result occur again, perform the resection measurement from step 3.

- Press **[RE OBS]** to measure the point designated in step 9. If no points are designated in step 9, all the points or only the final point can be observed again.



```
Resection
Start point
Last point
```

10. Press **[OK]** in the screen of step 6 to finish resection measurement. The instrument station coordinate is set.

Press **[YES]** when you want to set the azimuth angle of the first known point as the backsight point.

- Press **[NO]** to return to Meas Mode without setting the azimuth angle.

Note

• It is also possible to perform resection measurement when **[RESEC]** on Meas mode screen.

 Allocating **[RESEC]**: "24.2 Allocating Key Functions"

• Even if "inch" is selected in Config mode, standard deviation is displayed in "feet."

13.2 Height Resection Measurement

Only Z (height) of an instrument station is determined by the measurement.

- Known points must be measured by distance measurement only.
- Between 1 and 10 known points can be measured.

►PROCEDURE

1. In the second page of Meas mode screen, press **[MENU]**, then select "Resection".

2. Select "Elevation" and press **[EDIT]** to input the known point. After setting the elevation for the first known point, press **[▶]** to move to the second point. When all required known points have been set, press **[MEAS]**.

- Press **[◀]** to return to the previous known point.

3. Sight the first known point and press **[OBS]** to begin measurement. The measurement results are displayed on the screen.

4. Press **[YES]** to use the measurement results of the first known point.

5. If measuring two or more known points, repeat procedures 3 to 4 in the same way from the second point.

When the minimum quantity of observation data required for the calculation is present, **[CALC]** is displayed.

Resection.
NEZ
Elevation

◀	10th Pt.		
Zp:	11.891		
Tgt.h:	0.100m		
READ	REC	EDIT	MEAS

Resection	10th Pt.
Z	11.718
OBS	

13. RESECTION MEASUREMENT

6. Press **[CALC]** or **[YES]** to automatically start calculations after observations of all known points are completed. Instrument station elevation and standard deviation, which describes the measurement accuracy, are displayed.

7. Press **[RESULT]** to check the result.
If there are no problems in the result, press **{ESC}** and go to step 10.

Z	10.000
σZ	0.0022m
RESULT	REC OK

8. If there are problems with the results of a point, align the cursor with that point and press **[BAD]**.
“*” is displayed on the left of the point.

	σZ	
1st	-0.003	
2nd	-0.003	
3rd	0.000	
4th	0.002	▼
BAD	RE CALC	RE OBS ADD

9. Press **[RE CALC]** to perform calculation again without the point designated in step 8. The result is displayed.

If there are no problems with the result, go to step 10.

If problems with the result occur again, perform the resection measurement from step 3.

10. Press **[OK]** to finish resection measurement. Only Z (elevation) of the instrument station coordinate is set. N and E values are not overwritten.



Resection calculation process

The NE coordinates are found using angle and distance observation equations, and the instrument station coordinates are found using the method of least squares. The Z coordinate is found by treating the average value as the instrument station coordinates.

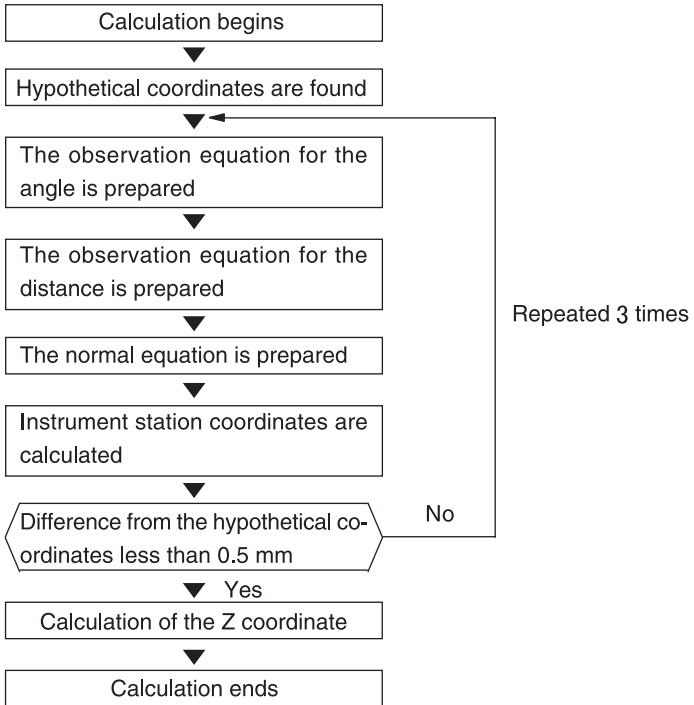

13. RESECTION MEASUREMENT



Precaution when performing resection

In some cases it is impossible to calculate the coordinates of an unknown point (instrument station) if the unknown point and three or more known points are arranged on the edge of a single circle.

An arrangement such as that shown below is desirable.

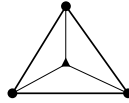

$\triangle \blacktriangle$: Unknown point

$\circ \bullet$: Known point

It is sometimes impossible to perform a correct calculation in a case such as the one below.

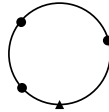

When they are on the edge of a single circle, take one of the following measures.

- (1) Move the instrument station as close as possible to the center of the triangle.

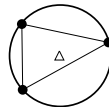

- (2) Observe one more known point which is not on the circle.

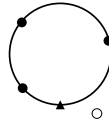

- (3) Perform a distance measurement on at least one of the three points.

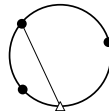

Caution

- In some cases it is impossible to calculate the coordinates of the instrument station if the included angle between the known points is too small. It is difficult to imagine that the longer the distance between the instrument station and the known points, the narrower the included angle between the known points. Be careful because the points can easily be aligned on the edge of a single circle.

14. SETTING-OUT MEASUREMENT

Setting-out measurement is used to set out the required point.

The difference between the previously input data to the instrument (the setting-out data) and the measured value can be displayed by measuring the horizontal angle, distance or coordinates of the sighted point.

The horizontal angle difference and distance difference are calculated and displayed using the following formulae.

Horizontal angle difference

dHA = Horizontal angle of setting-out data - measured horizontal angle

Distance difference

Distance Displayed item

Sdist: S-O S = measured slope distance - slope distance of setting-out data

Hdist: S-O H = measured horizontal distance - horizontal distance of setting-out data

Vdist: S-O V = measured height difference - height difference of setting-out data

- Setting out data can be input in various modes: slope distance, horizontal distance, height difference, coordinates and REM measurement.
- In slope distance, horizontal distance, height difference, and coordinate mode, registered coordinates can be recalled and used as setting-out coordinates. In slope distance, horizontal distance and height difference, S/H/V distances are calculated from the read in setting-out coordinate, instrument station data, instrument height, and target height.
- Setting-out measurement can be carried out effectively using the Guide light.
☞ "4.1 Parts of the Instrument", "5.1 Basic Key Operation" and "27.2 Optional Accessories"

14.1 Distance Setting-out Measurement

The point to be found based on the horizontal angle from the reference direction and the distance from the instrument station.

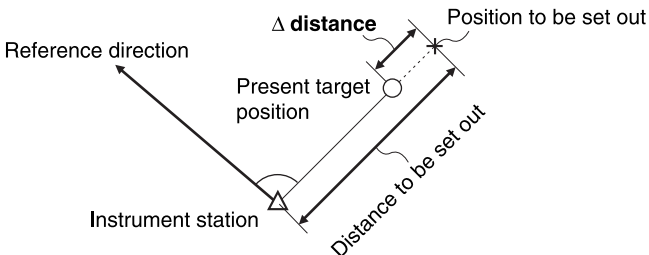

14. SETTING-OUT MEASUREMENT

►PROCEDURE

1. Press **[S-O]** in the third page of the Meas mode screen to display <S-O>.

2. Enter the instrument station data.

 "12.1 Entering Instrument Station Data, PROCEDURE Reading in Registered Coordinate Data".

3. Set the azimuth angle of the backsight point.

 "12.2 Azimuth Angle Setting" steps 2 to 6

4. Select "S-O data."

```
S-O
Stn. Orientation
S-O data
Observation
EDM
```

5. Press **[AS-O]** to select distance input mode.

Each time **[AS-O]** is pressed: S-O S (slope distance), S-O H (horizontal distance), S-O V (height difference), S-O Coord (coordinates), S-O Ht. (REM measurement).

 "14.2 Coordinates Setting-out Measurement", "14.3 REM Setting-out Measurement"

```
S-O S
Sdist: 0.000m
H ang: 0°00'00"
P1
READ AS-O EDIT OK
```

- When **[READ]** is pressed, registered coordinates can be recalled and used. Distance and angle are calculated using the coordinate value.

 "12.1 Entering Instrument Station Data, PROCEDURE Reading in Registered Coordinate Data"

6. Press **[EDIT]** and set the following items.

- (1) Sdist/Hdist/Vdist: distance from the instrument station to the position to be set out.
- (2) H ang: included angle between the direction of the reference and the point to be set out.

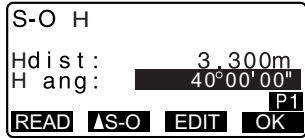

- Pressing **[COORD]** in the second page allows you to enter the coordinates of the point to be set out.

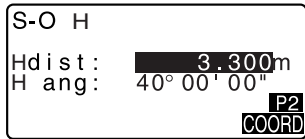

7. Press **[OK]** to set the input values.

8. Rotate the top of the instrument until "dHA" is 0° and place the target on the sight line.

9. Press **[OBS]** to start distance measurement. The target and the distance of the point to be set out is displayed (S-O H).

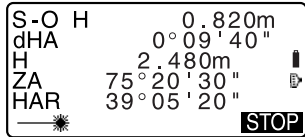
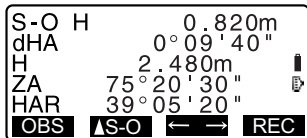

10. Move the prism forward and backward until the setting-out distance is 0m. If [S-O H] is "+", move the prism toward yourself, if it is "-", move the prism away from yourself.

14. SETTING-OUT MEASUREMENT

- By pressing [$\leftarrow \rightarrow$], an arrow pointing to the left or right displays which direction the target should be moved.

- \leftarrow : Move the prism to left.
- \rightarrow : Move the prism to right.
- \downarrow : Move the prism forward.
- \uparrow : Move the prism away.

When the target is within measurement range, all four arrows are displayed.

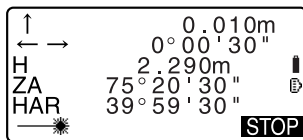

11. Press {ESC} to return to <S-O>.

- When [READ] was used in step 5, the list of registered coordinates is restored. Continue setting-out measurement.
 - [REC]: records measurement results
- Recording method:
"20. RECORDING DATA - RECORD MENU -"

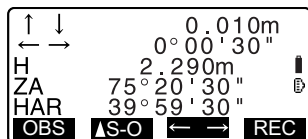

14.2 Coordinates Setting-out Measurement

After setting the coordinates for the point to be set out, the SET calculates the setting-out horizontal angle and horizontal distance. By selecting the horizontal angle and then the horizontal distance setting-out functions, the required coordinate location can be set out.

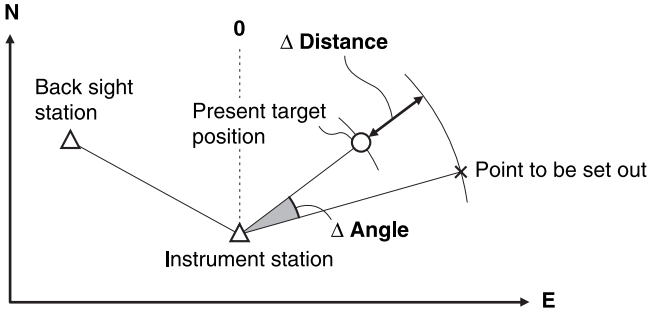

- To find the Z coordinate, attach the target to a pole etc. with the same target height.

► PROCEDURE

1. Press **[S-O]** on the third page of the Meas mode screen to display <S-O>.
2. Enter the instrument station data.
 "12.1 Entering Instrument Station Data PROCEDURE Reading in Registered Coordinate Data".
3. Set the azimuth angle of the backsight point.
 "12.2 Azimuth Angle Setting" steps 2 to 6
4. Select "S-O data" and press **[▲ S-O]** until <S-O Coord> is displayed.

14. SETTING-OUT MEASUREMENT

5. Press **[EDIT]**. Enter the coordinates of the setting-out point.

S-O Coord	
Np:	100.000
Ep:	100.000
Zp:	50.000
Tgt. h:	1.400m P1
READ	▲S-O EDIT OK

- When **[READ]** is pressed, registered coordinates can be recalled and used as setting-out coordinates.

 "12.1 Entering Instrument Station Data, PROCEDURE Reading in Registered Coordinate Data"



6. Press **[OK]** to set the setting-out data.

7. Press **[OBS]** to begin coordinate setting-out measurement.
Move the prism to find the point to be set out.

 "14.1 Distance Setting-out Measurement" steps 9 to 10

 : Move the prism upward.

 : Move the prism downward.

↓	1.988m	
→	2.015m	
▲	-1.051m	
ZA	89° 52' 50"	
HAR	150° 16' 10"	
OBS	▲S-O ← →	REC

8. Press **{ESC}** to return to <S-O>.
When **[READ]** was used in step 5, the list of registered coordinates is restored. Continue setting-out measurement.

14.3 REM Setting-out Measurement

To find a point where a target cannot be directly installed, perform REM setting-out measurement.

 "11.5 REM Measurement"

►PROCEDURE



1. Install a target directly below or directly above the point to be found, then use a measuring tape etc. to measure the target height (height from the surveying point to the target).
2. Press **[S-O]** in the Meas mode screen to display <S-O>.
3. Enter the instrument station data.
 "12.1 Entering Instrument Station Data, PROCEDURE Reading in Registered Coordinate Data".
4. Select "S-O data" and press **[▲S-O]** until <S-O Ht.> is displayed.
5. Press **[EDIT]**.
Input height from the surveying point to the position to be set out in "SO dist".
6. After inputting the data, press **[OK]**.

S-O Ht.	
Height:	3.300m
▲S-O	EDIT OK

14. SETTING-OUT MEASUREMENT

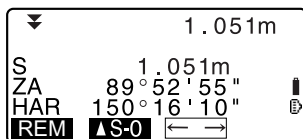
7. Press **[REM]** to begin REM setting-out measurement. Move the telescope to find the point to be set out.
-  "14.1 Distance Setting-out Measurement" steps 9 to 10



-  : Move the telescope near the zenith.
-  : Move the telescope near the nadir.

8. When the measurement is completed, press **{ESC}** to restore <S-O>.

15. SETTING-OUT LINE

Setting-out line is used for setting out a required point at a designated distance from the baseline and for finding the distance from the baseline to a measured point.

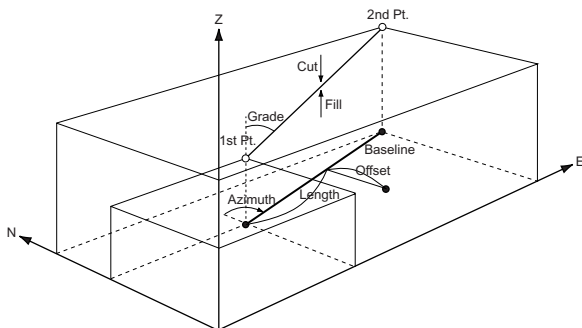

15.1 Defining Baseline

To perform setting-out line measurement, first, define the baseline. The baseline can be defined by inputting the coordinates of the two points. The scale factor value is the difference between the input coordinates and the observed coordinates.

$$\text{Scale (X, Y)} = \frac{\text{Hdist}' \text{ (horizontal distance calculated from the measured value)}}{\text{Hdist} \text{ (horizontal distance calculated from the input coordinates)}}$$

- When not observing first or second points, scale factor is set to "1".
- Defined baseline can be used in both setting-out line measurement and point projection.

►PROCEDURE

1. In the second page of Meas mode screen, press **[MENU]**, then select "Set-out line."

```
REM
Resection
Area calculation
Set-out line
Point projection
```

15. SETTING-OUT LINE

2. Enter the instrument station data.
☞ “12.1 Entering Instrument Station Data, PROCEDURE Reading in Registered Coordinate Data”.

3. Select “Define baseline” in <Set-out line> and press **[EDIT]**.

- When **[READ]** is pressed, registered coordinates can be recalled and used.

☞ “12.1 Entering Instrument Station Data, PROCEDURE Reading in Registered Coordinate Data”

```
Set-out line
Stn. Orientation
Define baseline
Set-out line
```

```
Define 1st Pt.  ►►
Np: 113.464
Ep: 91.088
Zp: 12.122
READ REC EDIT
```

4. Enter the first point data and press **{←}**.

5. Press **{▶}** to move to the second point.

6. Press **[EDIT]** and enter the second point data.

```
◀ Define 2nd Pt.
Np: 112.706
Ep: 104.069
Zp: 11.775
READ REC EDIT OK P1
```

7. Press **{FUNC}**.
[MEAS] is displayed.

- When not observing the first point and the second point, go to step 13.

```
◀ Define 2nd Pt.
Np: 112.706
Ep: 104.069
Zp: 11.775
P2
MEAS
```

8. Press **[MEAS]** on the screen of step 7 to move to observation of the first point.

9. Sight the first point and press **[OBS]**.

The measurement results are displayed on the screen.

Measure 1st Pt.	
N	113.464
E	91.088
Z	12.122
[OBS]	

- Press **[STOP]** to stop the measurement.
- You can input target height here.

10. Press **[YES]** to use the measurement results of the first point.

Measure 1st Pt.	
S	525.450m
ZA	80°30'15"
HAR	120°10'00"
Tgt.h	1.400m
[EDIT] [NO] [YES]	

- Press **[NO]** to observe the first point again.

11. Sight the second point and press **[OBS]**.

12. Press **[YES]** to use the measurement results of the second point.

The distance between the two measured points, the distance calculated from inputting the coordinates of two points and the scale factors are displayed.

Azimuth 93°20'31"	
Hcalc	13.003m
Hmeas	13.004m
ScaleX	1.000091
ScaleY	1.000091
[Sy=1] [Sy=Sx] [EDIT] [OK]	

Grade	%-2.669
[1:**] [%] [OK]	

13. Press **[OK]** on the screen of step 13 to define the baseline. <Set-out line> is displayed. Move to setting-line measurement.

[C] "15.2 Setting-out Line Point"/
"15.3 Setting-out Line Line"

Set-out line	
[Point]	
Line	

- Press **[Sy=1]** to set scale factor y to "1".
- Press **[1 : **]** to change the grade display mode to "1 : ** = elevation : horizontal distance".

15. SETTING-OUT LINE



- It is also possible to perform setting-out line measurement when **[S-O LINE]** on the Meas mode screen.



Allocating **[S-O LINE]**: "24.2 Allocating Key Functions".

15.2 Setting-out Line Point

Setting-out line point measurement can be used to find the required point coordinate by inputting the length and offset based on the baseline.

- Before performing setting-out line point, the baseline must be defined.

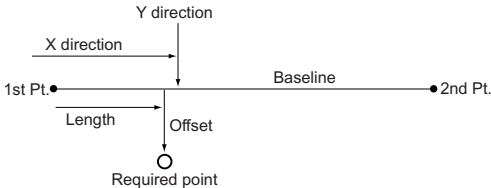

►PROCEDURE

- Select "Point" in <Set-out line>



- Press **[EDIT]**.

Set the following items.

- (1) Length: Distance along the baseline from the first point to the position at which a line extending from the required point intersects the baseline at right angles (X direction).
- (2) Offset: Distance from the required point to the position at which a line extending from the required point intersects the baseline at right angles (Y direction).

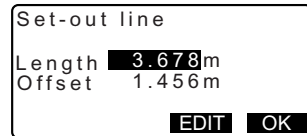

- Press **[OK]** on the screen of step 2. The coordinate value of the required point is calculated and displayed.

Set-out line	
N	111.796
E	94.675
Z	12.024
REC ▲S-O	

- **[REC]**: records the coordinate value as a known point data.
☞ Recording method:
 "22.1 Registering/Deleting Known Point Data"
- Press **▲S-O** to move to setting-out measurement of the required point.
☞ "14. SETTING-OUT MEASUREMENT"

- Press **{ESC}**. Continue the measurement (repeat steps from 4).

15.3 Setting-out Line Line

Setting-out line line measurement tells how far horizontally the measured point is from the baseline and how far vertically the measured point is from the connected line. The baseline can be offset in a horizontal direction if necessary.

- Before performing setting-out line line, the baseline must be defined.

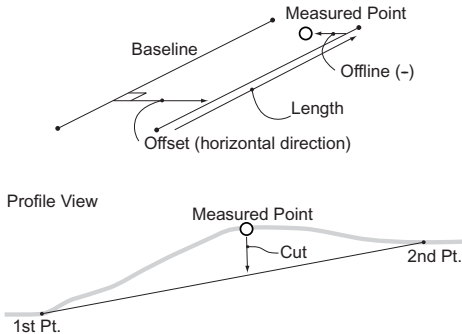

►PROCEDURE

1. Select "Line" in <Set-out line>.

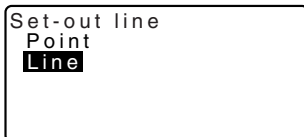

2. Press **[EDIT]** and enter the offset value.

- Offset: How much to move the baseline.

Right side indicates positive value and left side indicates negative value.

- When not setting offset value, go to step 3.

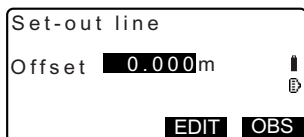

3. Sight the target and press **[OBS]** on the screen of step 2.
The measurement results are displayed on the screen.
Press **[STOP]** to stop the measurement.

4. Press **[YES]** to use the measurement results.
Displays the difference between the measured point and the baseline.

Set-out line	
S	525.450m
ZA	80°30'15"
HAR	120°10'00"
Tgt.h	1.400m
EDIT	NO YES

- Offline: A positive value indicates the point is on the right of the baseline and a negative value indicates it is on the left.
 - "Cut" indicates that the point is below the baseline.
 - "Fill" indicates that the point is above the baseline.
 - Length: Distance along the baseline from the first point to the measured point.
 - Press **[NO]** to observe the target again.
5. Sight the next target and press **[OBS]** to continue the measurement.
- Press **[REC]**: records measurement results.
-  Recording method:
"20. RECORDING DATA - RECORD MENU -"

Set-out line	
Offline	-0.004m
Cut	0.006m
Length	12.917m
REC	OBS

16. POINT PROJECTION

Point projection is used for projecting a point onto the baseline. The point to project can be either measured or input. Displays the distances from the first point and point to project to the position at which a line extending from point to project intersects the baseline at right angles.

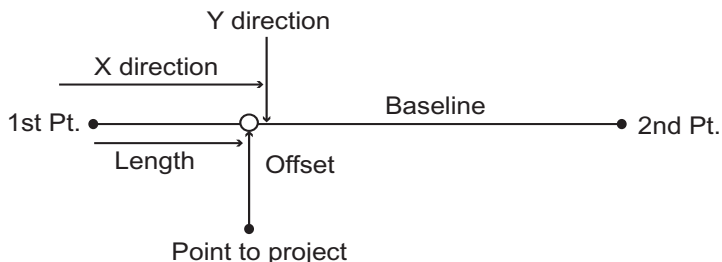

16.1 Defining Baseline

- Defined baseline can be used in both setting-out line measurement and point projection.

► PROCEDURE

1. In the second page of Meas mode screen, press **[MENU]**, then select "Point Projection".

```
REM
Resection
Area calculation
Set-out line
Point projection
```

2. Enter the instrument station data then define the baseline.
 "15.1 Defining Baseline" step 2 to 13

3. Press **[OK]** to define the baseline. <Point projection> is displayed. Move to point projection measurement.
 "16.2 Point Projection"

```
Point projection
Np: 103.514
Ep: 101.423
Zp: 12.152
P1
READ OBS EDIT OK
```



- It is also possible to perform setting-out line measurement when **[P-PROJ]** on the Meas mode screen.

Allocating the function key: "24.2 Allocating Key Functions"

16.2 Point Projection

Before performing point projection, the baseline must be defined.

► PROCEDURE

- Define the baseline.
 - "16.1 Defining Baseline"
- Select "Point Projection" in <Point Projection>.

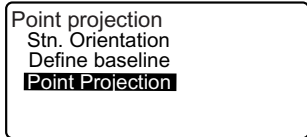

- Press **[EDIT]**, enter the point coordinate.
 - Press **[OBS]** to observe the point to project.
 - When recording the data as a known point, press **{FUNC}**, and then press **[REC]** on the second page.

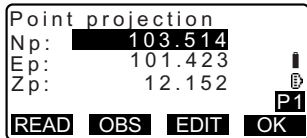

Recording method:
"22.1 Registering/Deleting
Known Point Data"

- Press **[OK]** on the screen of step 3.
The following items are calculated and displayed.

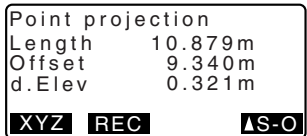

- Length: Distance along the baseline from the first point to the projected point (X direction).

16. POINT PROJECTION

- Offset: Distance from point to project to the position at which a line extending from point of project intersects the baseline at right angles. (Y direction).
- d.Elev: Elevation between the baseline and the projected point.
- Press **[XYZ]** to switch the screen display to coordinate values.
- Press **[OFFSET]** to switch the screen display to distance values.
- Press **[REC]**: records the coordinate value as a known point data.

 Recording method:
"22.1 Registering/Deleting
Known Point Data"

- Press **[▲ S-O]** to move to setting-out measurement of the projected point.

 "14. SETTING-OUT
MEASUREMENT"

5. Press **{ESC}**. Continue the measurement (repeat steps from 3).

17. OFFSET MEASUREMENT

Offset measurements are performed in order to find a point where a target cannot be installed directly or to find the distance and angle to a point which cannot be sighted.

- It is possible to find the distance and angle to a point you wish to measure (target point) by installing the target at a location (offset point) a little distance from the target point and measuring the distance and angle from the surveying point to the offset point.
- The target point can be found in the three ways explained below.

17.1 Single-distance Offset Measurement

Finding it by entering the horizontal distance from the target point to the offset point.

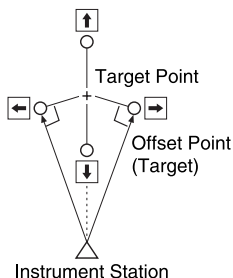

- When the offset point is positioned to the left or right of the target point, make sure the angle formed by lines connecting the offset point to the target point and to the instrument station is almost 90° .
- When the offset point is positioned in front of or behind the target point, install the offset point on a line linking the instrument station with the target point.

► PROCEDURE

1. Set the offset point close to the target point and measure the distance between them, then set up a prism on the offset point.

17. OFFSET MEASUREMENT

- Sight the offset point and press **[DIST]** in the first page of the Meas mode screen to begin measurement.
The measurement results are displayed. Press **[STOP]** to stop the measurement.

- Press **[OFFSET]** in page three of Meas mode to display <Offset>.

- Enter the instrument station data.
☞ "12.1 Entering Instrument Station Data, PROCEDURE Reading in Registered Coordinate Data".

- Select "Offset/Dist" and press **[EDIT]**.

Input the following items.

- Horizontal distance from the target point to the offset point.
- Direction of the offset point.

- Direction of offset point

← : On the left of the target point.

→ : On the right of the target point.

↓ : Closer than the target point.

↑ : Beyond the target point.

- Press **[OBS]** to re-observe the offset point.

- Press **[OK]** on the screen of step 5 to calculate and display the distance and angle of the target point.

```
Offset
Stn. Orientation
Offset/Dist
Offset/Angle
Offset/2D
```

```
S      34 770m
ZA     80°30'10"
HAR 120°10'00"
Dist:  2.000m
Direc: →
OBS   EDIT   OK
```

```
Offset/Dist
S      34.980m
ZA     85°50'30"
HAR    125°30'20"
REC   XYZ   NO   YES
```

7. Press **[YES]** to return to <Offset>.

- Press **[XYZ]** to switch the screen display from distance values to coordinate values. Press **[HVD]** to return to distance values.
- Press **[No]** to return to the previous of distance and angle.
- To record the calculation result, press **[REC]**.

 "20. RECORDING DATA - RECORD MENU -"

17.2 Angle Offset Measurement

Sighting the direction of the target point to find it from the included angle. Install offset points for the target point on the right and left sides of and as close as possible to the target point and measure the distance to the offset points and the horizontal angle of the target point.

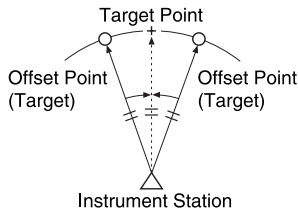

►PROCEDURE

1. Set the offset points close to the target point (making sure the distance from the instrument station to the target point and the height of the offset points and the target point are the same), then use the offset points as the target.

17. OFFSET MEASUREMENT

- Sight the offset point and press **[DIST]** in the first page of the Meas mode screen to begin measurement.
The measurement results are displayed. Press **[STOP]** to stop the measurement.
- Press **[OFFSET]** in page three of Meas mode to display <Offset>.
- Enter the instrument station data.
☞ "12.1 Entering Instrument Station Data, PROCEDURE Reading in Registered Coordinate Data".
- Select "Offset/Angle" in <Offset>.

```
Offset
Stn. Orientation
Offset/Dist
Offset/Angle
Offset/2D
```

- Accurately sight the direction of the target point and press **[OK]**.
The distance and angle of the target point are displayed.

```
S          34.770m
ZA      80°30'10"
HAR     120°10'00"
2nd obs.OK?
OBS OK
```

- After finishing measurement, press **[YES]** to return to <Offset>.

```
Offset/Angle
S          34.980m
ZA      85°50'30"
HAR     125°30'20"
REC XYZ NO YES
```

17.3 Two-distance Offset Measurement

By measuring the distances between the target point and the two offset points. Install two offset points (1st target and 2nd target) on a straight line from the target point, observe the 1st target and 2nd target, then enter the distance between the 2nd target and the target point to find the target point.

- It is possible to make this measurement easily using the optional equipment: the 2-point target (2RT500-K). When using this 2-point target, be sure to set prism constant to 0.

 "24.1 Changing Instrument Options ● EDM settings"

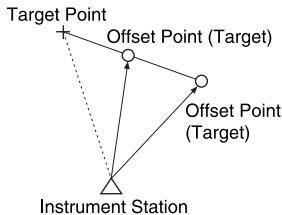

How to use 2-point target (2RT500-K)

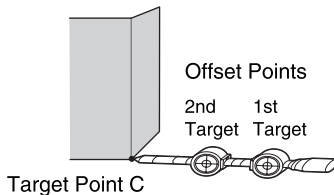

- Install the 2-point target with its tip at the target point.
- Face the targets toward the instrument.
- Measure the distance from the target point to the 2nd target.
- Set the reflector type to "sheet".

► PROCEDURE

- Install two offset points (1st target, 2nd target) on a straight line from the target point and use the offset points as the target.

17. OFFSET MEASUREMENT

- Press **[OFFSET]** in page three of Meas mode to display <Offset>.
- Enter the instrument station data.
 "12.1 Entering Instrument Station Data, PROCEDURE Reading in Registered Coordinate Data".
- Select "Offset/2D" in <Offset>.

Offset
Stn. Orientation
Offset/Dist
Offset/Angle
Offset/2D

- Sight the 1st target and press **[OBS]**.
Observation begins and the measurement results are displayed.
Press **[YES]**. The "2nd Target Observation Screen" is displayed.

Observe 1st o/s
ZA 73° 18' 00"
HAR 250° 12' 00"
OBS

- Sight the 2nd target and press **[OBS]**.
The measurement results are displayed. Press **[YES]**.

N 10.480
E 20.693
Z 15.277
Confirm?
NO YES

- Enter the distance from the 2nd target to the target point and press **[←]**. The coordinates of the target point are displayed.

B-C: 1.2000m
1 2 3 4

- Press **[YES]**. <Offset> is restored.

- When **[HVD]** is pressed, display mode is switched from coordinates to S, ZA, HAR.

Offset/2D
N 10.480
E 20.693
Z 15.277
REC HVD NO YES

18. MISSING LINE MEASUREMENT

Missing line measurement is used to measure the slope distance, horizontal distance, and horizontal angle to a target from the target which is the reference (starting point) without moving the instrument.

- It is possible to change the last measured point to the next starting position.
- Measurement result can be displayed as the gradient between two points.

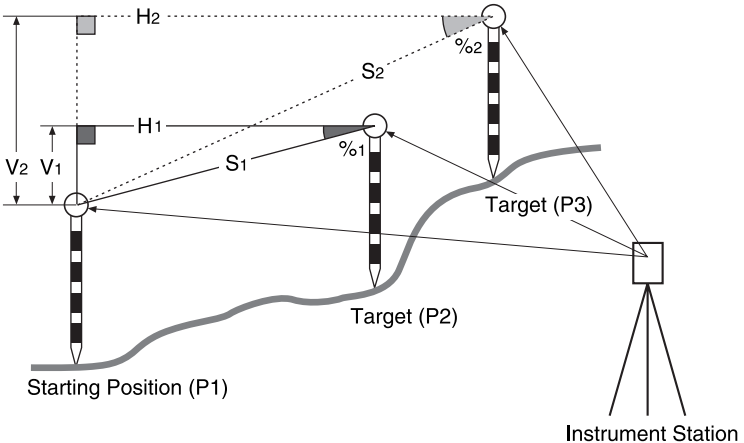

18.1

Measuring the Distance between 2 or more Points

► PROCEDURE

1. Sight the target of the starting position, and press **[DIST]** in the first page of Meas mode to begin measurement.
The measured values are displayed.
Press **[STOP]** to stop measurement.

18. MISSING LINE MEASUREMENT

2. Sight the second target and press **[MLM]** in the third page of Meas mode to begin observation.

The following values are displayed:

- S : Slope distance of the starting position and 2nd target.
H : Horizontal distance of the starting position and 2nd position.
V : Height difference of the starting position and 2nd target.

MLM			
S	20.757m	🔋	
H	27.345m	📶	
V	1.012m		
[MLM]	[MOVE]	[S/%]	[OBS]

3. Sight the next target and press **[MLM]** to begin observation.

Slope distance, horizontal distance and height difference between multiple points and the starting position can be measured this way.

- When **[S/%]** is pressed, the distance between two points (S) is displayed as the gradient between two points.
- Press **[OBS]** to re-observe the starting position. Sight the starting position and press **[OBS]**.
- When **[MOVE]** is pressed, the last target measured becomes the new starting position to perform missing line measurement of the next target.

📄 "18.2 Changing the Starting Point"

4. Press **{ESC}** to end missing line measurement.

18.2 Changing the Starting Point

It is possible to change the last measured point to the next starting position.

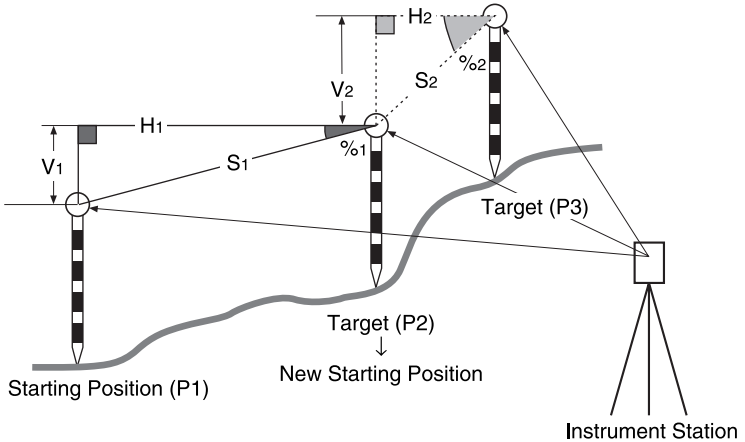

► PROCEDURE

1. Observe the starting position and target following steps 1 to 3 in "18.1 Measuring the Distance between 2 or more Points".
2. After measuring the targets, press **[MOVE]**.
Press **[YES]**.
 - Press **[NO]** to cancel measurement.

MLM			
S	20.757m		
H	27.345m		
V	1.012m		
MLM		MOVE	S/%
		OBS	

MLM			
Move 1st obs ?			
S	34.980m		
ZA	85° 50' 30"		
HAR	125° 30' 20"		
		NO	YES

18. MISSING LINE MEASUREMENT

3. The last target measured is changed to the new starting position.
Perform missing line measurement following steps 2 to 3 in "18.1 Measuring the Distance between 2 or more Points".

19. SURFACE AREA CALCULATION

You can calculate the area of land enclosed by three or more known points on a line by inputting the coordinates of the points.

Input

Coordinates: P1 (N1, E1)
P2 (N1, E2)
P3 (N3, E3)

Output

Surface area: S

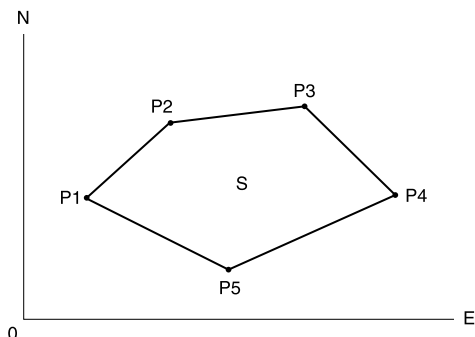

- Number of specified coordinate points: 3 or more, 30 or less
- Surface area is calculated by observing the points on a line enclosing an area in order or reading in the previously registered coordinates in order.

Caution

- If two or less points are used to measure an area, an error will occur.
- Be sure to observe (or recall) points on an enclosed area in a clockwise or counterclockwise direction. For example, the area specified by entering (or recalling) point numbers 1, 2, 3, 4, 5 or 5, 4, 3, 2, 1 implies the same shape. However, if points are not entered in numerical order, the surface area will not be calculated correctly.

► PROCEDURE Surface area calculation by observing points

1. In the second Meas mode screen, press **[MENU]**, then select "Area calculation".

```
REM
Resection
Area calculation
Set-out line
Point projection
```

19. SURFACE AREA CALCULATION

2. Sight the first point on the line enclosing the area, and press **[MEAS]**.
Press **[OBS]** to begin observation. The measured values are displayed.

```
01:Pt_01
02:
03:
04:
05:
READ MEAS
```

```
N          12.345
E          137.186
Z          1.234
ZA        90°01'25"
HAR       109°32'00"
OK OBS
```

3. Press **[OK]** to enter the value of point 1 in "Pt.01".

```
01:Pt_01
02:
03:
04:
05:
MEAS
```

4. Repeat steps 2 to 3 until all points have been measured. Points on an enclosed area are observed in a clockwise or counterclockwise direction.

For example, the area specified by entering point numbers 1, 2, 3, 4, 5 or 5, 4, 3, 2, 1 implies the same shape.

After all known points necessary to calculate the surface area have been observed, **[CALC]** is displayed.

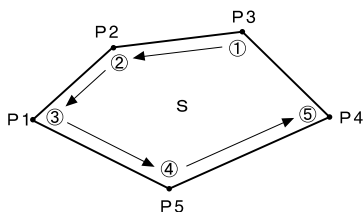

5. Press **[CALC]** to display the calculated area.

```
01:Pt_01
02:Pt_02
03:Pt_03
04:Pt_04
05:Pt_05
CALC MEAS
```

6. Press **[OK]** to quit area calculation and return to Meas Mode.

```
Area calculation
Pt.3
Area          468.064m2
              0.0468ha
OK
```

►PROCEDURE Surface area calculation by reading in the points' coordinates

- In the second Meas mode screen, press **[MENU]**, then select "Area calculation".

- Press **[READ]** to display the list of coordinate data.

Pt. : Known point date
saved in the current
JOB or in the
Coordinate Search
JOB.

Crd./ Stn : Coordinate data saved
in the current JOB or in
the Coordinate Search
JOB.

```

01 : Pt_01
02 :
03 :
04 :
05 :
[READ] [MEAS]
  
```

- Select the first point in the list and press **[←]**.

The coordinates of the first point is set as "Pt.001".

```

Pt. Pt.001
Pt. Pt.002
Pt. Pt.004
Pt. Pt.101
Pt. Pt.102
[↑·P] [TOP] [LAST] [SRCH]
  
```

- Repeat steps 2 to 4 until all points have been read in.

Points on an enclosed area are read in a clockwise or counterclockwise direction.

After all known points necessary to calculate the surface area have been observed, **[CALC]** is displayed.

```

01 : Pt.004
02 :
03 :
04 :
05 :
[READ]
  
```

- Press **[CALC]** to display the calculated area.

- Press **[OK]** to quit area calculation and return to Meas Mode.

```

Area calculation
Pt.3
Area      468.064m2
           0.0468ha
[OK]
  
```

19. SURFACE AREA CALCULATION



- It is also possible to perform area measurement when **[AREA]** on the Meas mode screen.

 Allocating **[AREA]**: “24.2 Allocating Key Functions”

20. RECORDING DATA - RECORD MENU -

In Record menu, you can store the measurement data (distance, angle, coordinates), station point data and note in the current JOB.

 "21. SELECTING / DELETING A JOB"

- A total of 10000 data can be stored inside the instrument.

 Note

- If the same point number is input, the following screen is displayed.

N	5.544
E	-0.739
Z	0.245
Pt.	PNT-001
	Overwrite ?
ADD	NO YES

Press **[YES]** to overwrite the present point.

Press **[NO]** to input a new name.

Press **[ADD]** to record the point as another record with the same name.

20.1 Recording Instrument Station Data

Instrument station data can be stored in the current JOB.

- The items that can be recorded are the instrument station coordinates, point number, instrument height, codes, operator, date, time, weather, wind, temperature, air pressure and atmospheric correction factor.
- If instrument station data is not stored for the current JOB, the previously stored instrument data settings will be used.

► PROCEDURE

1. Press **[REC]** in the third page of Meas mode to display <REC>.
 - Current JOB name is displayed.
2. Select "Stn data".

- Select **[READ]** to recall and use the registered coordinates.

 "12.1 Entering Instrument Station Data, PROCEDURE Reading in Registered Coordinate Data"

REC
Stn data
Angle data
Dist data
Coord data
Dist + Coord data

20. RECORDING DATA - RECORD MENU -

3. Press **[EDIT]** and set the following data items.

- (1) Instrument station coordinates
- (2) Point number
- (3) Instrument height
- (4) Codes
- (5) Operator
- (6) Date
- (7) Time
- (8) Weather
- (9) Wind
- (10) Temperature
- (11) Air pressure
- (12) Atmospheric correction factor

- When inputting code, press **[↑]** / **[↓]** to use the registered codes. Align the cursor where you want to input the registered code.
- To set the atmospheric correction factor to 0ppm, press **[0ppm]**. The temperature and air pressure are set to the default setting.

N0:	56.789
E0:	-1234567.789
Z0:	1.234
Pt.:	Pt.004
Inst.h:	1.234m
OK	READ EDIT

Code	↑
:pole	
Operator:	↓
:SOKKIA	
OK	↑ ↓ EDIT

Date	: Jan/28/2001	↑
Time	: 00:00:00	
Weather:	Fine	↓
Wind	: Calm	
OK		

Temp.:	12°C	↑
Press.:	1013hPa	
ppm	: -3	↓
OK	0ppm	EDIT

4. Check the input data, then press **[OK]**.

5. Press **{ESC}** to quit measurement and restore <REC>.

Note

- SET automatically increments the last input number by 1.
- Maximum point number size: 14 (alphanumeric)
- Input range of target height: -9999.999 to 9999.999 (m)
- Maximum code/operator size: 16 (alphanumeric)
- Weather selection: Fine, Cloudy, Light rain, Rain, Snow
- Wind selection: Calm, Gentle, Light, Strong, Very strong
- Temperature range: -30 to 60 (°C) (in 1°C step)/-22 to 140 (°F) (in 1°F step)
- Air pressure range: 500 to 1400 (hPa) (in 1 hPa step)/375 to 1050 (mmHg) (in 1mmHg step)/14.8 to 41.3 (inch Hg) (in 0.1 inch Hg step)
- Atmospheric correction factor range (ppm): -499 to 499

20.2 Recording Angle Measurement Data

Angle measurement data can be stored in the current JOB.

- It is convenient to use **[AUTO]** to perform automatic operation from angle measurement to recording.

►PROCEDURE

1. Press **[REC]** in the third page of Meas mode to display <REC>.
2. Select "Angle data" and sight the point to be recorded.
Angle measurement values are displayed in real time.
3. Press **[REC]**, then press **[EDIT]**.
Set the following items.
 - (1) Point number
 - (2) Target height
 - (3) Code
4. Check the input data, then press **[OK]**.
5. To continue measurement, sight the next point, then perform steps 3 and 4 above.

```

REC
Stn data
Angle data
Dist data
Coord data
Dist + Coord data
  
```

```

REC/Angle rec 2922
ZA 60°15'40"
HAR 110°30'45"
Pt.:Pt.002
AUTO 0SET REC
  
```

```

ZA 60°15'40"
HAR 110°30'45"
Pt.: Pt.002
Tgt.h: 1.234m
1 2 3 4
  
```

```

Code
:
.
OK ↑ ↓ EDIT
  
```

20. RECORDING DATA - RECORD MENU -

- Press **[AUTO]** to perform angle measurement and automatically record the results. **[AUTO]** is convenient for recording measurement data when point number, code, and target height are not set.

```
REC/Angle      rec 2923
ZA      80°30'15"
HAR     120°10'00"
Pt.:Pt.001
        Recorded
```

6. Press **{ESC}** to quit measurement and restore <REC>.

20.3 Recording Distance Measurement Data

Distance measurement data can be stored in the current JOB.

►PROCEDURE

1. Press **[DIST]** in the first page of Meas mode to perform distance measurement.

 "11.2 Distance and Angle Measurement"

2. Press **[REC]** in the third page of Meas mode. <REC> is displayed. Select "Dist data" to display the measurement results.

```
REC
Stn data
Angle data
Dist data
Coord data
Dist + Coord data
```

3. Press **[REC]**, then press **[EDIT]**. Set the following items.

- (1) Point number
- (2) Target height
- (3) Code

```
REC/Dist      rec 2923
S      123.456m
ZA      80°30'15"
HAR     120°10'00"
Pt.:Pt.001
[AUTO] [DIST] [OFFSET] [REC]
```

```
S      123.456m
ZA      80°30'15"
HAR     120°10'00"
Pt: [Pt.001]
Tgt.h: 1.234m
1 2 3 4
```

4. Check the input data, then press **[OK]**.

5. To continue measurement, sight the next point, press **[DIST]**, then perform steps 3 and 4 above.

- Press **[OFFSET]** to offset measurement in Record Mode.

```
REC/Dist   rec 2922
S          123.456m
ZA        80°30'15"
HAR       120°10'00"
Pt. : Pt.001
AUTO DIST OFFSET
```

6. Press **{ESC}** to quit measurement and restore <REC>.

- When the same point number data is overwritten, the overwritten data is deleted.



- Once the data has been recorded, **[REC]** is not displayed in order to prevent double recording.

20.4 Recording Coordinate Data

Coordinate data can be stored in the current JOB

►PROCEDURE

1. Perform coordinates measurement in the Meas mode screen.

"12. COORDINATE MEASUREMENT"

2. Press **[REC]** in the third page of Meas mode to display <REC>. Select "Coord data" to display the measurement results.

```
REC
Stn data
Angle data
Dist data
Coord data
Dist + Coord data
```

```
REC/Coord   rec 2923
N           344.284
E           125.891
Z           15.564
Pt. : Pt.003
AUTO OBS OFFSET REC
```

20. RECORDING DATA - RECORD MENU -

- Press **[REC]**, then press **[EDIT]**.
Set the following items.
 - Point number
 - Code
 - Target height

N	344.284		
E	125.891		
Z	15.564		
Pt.:	Pt.003		
Tgt.h:	2.000m		
1	2	3	4

- Check the input data, then press **[OK]**.
- To continue measurement, sight the next point, press **[OBS]**, then perform steps 3 and 4 above.
- Press **{ESC}** to quit measurement and restore <REC>.

20.5 Recording Distance and Coordinate Data

Distance measurement data and coordinate data can be stored in the current JOB at the same time.

- Both distance measurement data and coordinate data are recorded as the same point number.
- Distance measurement data is recorded first, then coordinate data is recorded.

►PROCEDURE

- Press **[REC]** in the third page of Meas mode to display <REC>.
- Select "Dist + Coord data" to display <REC/DIST + C>.
- Sight the point and press **[OBS]** to begin the measurement.
The measurement results are displayed.

REC
Stn data
Angle data
Dist data
Coord data
Dist + Coord data

REC/DIST+C	rec 3970	
N	0.051	
E	-0.004	
Z	1.486	
Pt.	PNT-1234	
AUTO	OBS	OFFSET

4. Press **[REC]**, then press **[EDIT]**.
Set the following items.
- (1) Point number
 - (2) Target height
 - (3) Code

```
REC/DIST+C  rec 3970
N           0.051
E          -0.004
Z           1.486
Pt. PNT-1234
AUTO OBS OFST REC
```

```
N           0.051
E          -0.004
Z           1.486
Pt.           PNT-1234
Tgt_h      0.000m
OK EDIT
```

5. Check the input data, then press **[OK]**.
6. Press **{ESC}** to quit measurement and restore <REC>.

20.6 Recording Notes

This procedure prepares notes data and records it in the JOB which is selected.

►PROCEDURE

1. Press **[REC]** in the third page of Meas mode to display <REC>. Select "Note".
2. Press **[EDIT]** and enter the note data.
3. After inputting the note data, press **[OK]** to return to <REC>.

```
Note
View
```

```
REC/Note  rec 2823
Tree 01 Left
OK EDIT
```



- Maximum note length: 60 characters (alphanumeric)

20.7 Reviewing JOB Data

It is possible to display the data within the current JOB that is selected.

- It is possible to search for data within the JOB to be displayed by point number. But the note data cannot be searched.
- Known point data that are entered from an external instrument are not reviewed.

►PROCEDURE Reviewing JOB data

1. Press **[REC]** in the third page of Meas mode to display <REC>. Select "View" to display the list of recorded points.



2. Select the point number to be displayed in detail and press **[←→]**. Details of the data is displayed. This screen contains distance measurement data.

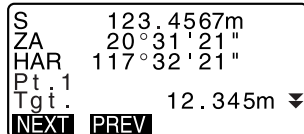
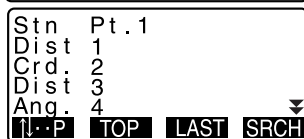

- To display previous data item, press **[PREV]**.
- To display next data, press **[NEXT]**.
- **[↑↓...P]** = Use {▲} / {▼} to move from page to page.
- **[↑↓...P]** = Use {▲} / {▼} to select individual point.
- Press **[TOP]** to display first data.
- Press **[LAST]** to display last data.
- Press **[SRCH]** to search for point number. Input the point number after "Pt. No."

- The search may take time if many data are registered.
3. Press **{ESC}** to conclude detailed display and restore the list of points.
Press **{ESC}** again to restore <REC>.



- If more than two points with the same point name exist in the current JOB, SET finds the newer data only.

21. SELECTING / DELETING A JOB

21.1 Selecting a JOB

Select the current JOB and Coordinate Search JOB.

- A total of 10 JOBS have been prepared, and JOB1 was selected when your SET was shipped from the factory.
- The names of the JOBS have been preset as JOB1 to JOB10; you can change them to any names you wish.
- Scale factor can be set for each JOB. Only scale factor of the current JOB can be edited.



Current JOB

Measurement results, instrument station data, known points data, notes and coordinate data are recorded in the current JOB.

 Registering known point data: "22.1 Registering/Deleting Known Point Data".



Coordinate Search JOB

The registered coordinate data in the JOB selected here can be read into coordinate measurement, resection measurement, setting-out measurement, etc.



Scale correction

SET calculates horizontal distance and coordinates of a point using measured slope distance. If scale factor has been set, scale correction is carried out during calculation.

$$\text{Corrected horizontal distance (s)} = \text{Horizontal distance (S)} \times \text{Scale factor (S.F.)}$$

- When scale factor is set to "1.00000000", the horizontal distance is not corrected.

► PROCEDURE JOB selection and scale factor setting

1. Select "JOB" in Memory Mode.

Memory
JOB
Known data
Code

2. Select "JOB selection".
 <JOB selection> is displayed.

```
JOB
JOB selection
JOB name edit
JOB deletion
Comms output
Comms setup
```

```
JOB selection
: JOB1
S.F.=1.00000000
Coord search JOB
: JOB
LIST S.F.
```

3. Press [LIST].

- JOB can also be selected by pressing {▶}/{◀}.
- The numbers to the right represent the number of data items in each JOB.
- "*" means that the JOB has not been output to an external device yet.

```
JOB selection
JOB01 46
*ATUG1 254
JOB03 0
JOB04 0
JOB05 0▼
```

4. Align the cursor with the desired JOB as the current JOB and press {←}.
 The JOB is determined .

5. Press [S.F.] and then press [EDIT].
 Enter the scale factor for the current JOB.

```
JOB 1
S.F.=1.00000000
EDIT OK
```

6. Press [OK].
 JOB selection screen is restored.

7. Align the cursor with "Coord search JOB" and press [LIST].
 <Coord search JOB> is displayed.

21. SELECTING / DELETING A JOB

- Align the cursor with the desired JOB as the coordinate search JOB and press {←}.
The JOB is determined and <JOB> is restored.



- The list of JOB names is contained on up to 2 pages.
 - Scale factor input range : 0.50000000 to 2.00000000 (*1.00000000)
- “*” : Factory setting

►PROCEDURE Inputting a JOB name

- Select “JOB” in Memory mode.
- Select in advance the JOB whose name to be changed.
 “PROCEDURE JOB selection and scale factor setting”
- Select "JOB name edit" in <JOB>.
Input the new job name and press {←}.
<JOB> is restored.

```
JOB
JOB selection
JOB name edit
JOB deletion
Comms output
Comms setup
```

```
JOB name edit
JOB03
A
A B C D
```



- Maximum size of JOB name: 12 (alphanumeric)

21.2 Deleting a JOB

It is possible to clear the data within a designated JOB. After the data has been cleared, the JOB name returns to the name allocated when the SET was shipped.



- A JOB that has not been output to an auxiliary device (displayed with *) cannot be deleted.

►PROCEDURE

1. Select "JOB" in Memory Mode.

2. Select "JOB deletion."
<JOB deletion> is displayed.

```
JOB
JOB selection
JOB name edit
JOB deletion
Comms output
Comms setup
```

- The numbers to the right represent the number of data items in each JOB.

```
JOB deletion
JOB01          46
ATUG1         254
*JOB03         0
JOB04         0
JOB05         0
```

3. Align the cursor with the desired JOB and press {←}.

4. Press [YES]. The data within the JOB that is selected is deleted and <JOB deletion> is restored.

```
JOB03
deletion
Confirm ?
NO YES
```

22. REGISTERING/DELETING DATA

22.1 Registering/Deleting Known Point Data

It is possible to register or delete coordinate data of the known points in the current JOB.

The coordinate data that has been registered can be output during setting for use as instrument station, backsight station, known point, and setting-out point coordinate data.

- It is possible to register 10000 items of coordinate data, including the data inside the JOBS.
- There are two registration methods: key entry and entry from an external instrument.
 - ☞ Communication cables: "27.2 Optional Accessories"
 - Output format and command operations: "Interfacing with the SOKKIA SDR Electronic Field Book" and "Command Explanations" manuals.
- When entering known point data from an external device, SET does not check the repeated point number.
- Communication setup can be performed in the known data as well. Select "Comms Setup" in <Known data>.

Caution

- When "inch" is selected as the distance unit, the value must be input in "feet."

► PROCEDURE Using the key entry method to register known point coordinate data

1. Select "Known data" in Memory Mode.

- Current JOB name is displayed.

```
Memory
JOB
Known data
Code
```

2. Select "Key in coord" and input known point coordinates and point number.

```
Known data
Job:JOB1
Key in coord
Comms input
Deletion
View
```

```
rec 3991
N 567.950
E -200.820
Z 305.740
Pt. 5
1 2 3 4
```

3. After setting the data, press **{←}**.
The coordinate data is recorded in the current JOB and screen in step 2 is restored.

```

                                rec 2641
N      567.950
E      -200.820
Z      305.740
Pt.    5
        Recorded
    
```

4. Continue to enter other known point coordinate data.
5. After the registration of all the coordinate data has been completed, press **{ESC}** to restore <Known data>.

► PROCEDURE Entering known point coordinate data from an external instrument

1. Connect SET and host computer.
2. Select "Known data" in Memory Mode.
- Current JOB name is displayed.

3. Select "Comms input" to display <Comms input>.
Coordinate data starts to be entered from an external instrument and the number of received items is displayed on the screen. When data reception is completed, <Known data> is displayed.

```

Known data
Job.JOB1
Key in coord
Comms input
Deletion
View
    
```

```

Comms input
Format    SDR
Receiving  12
    
```

- Press **{ESC}** to stop data reception in progress.

► **PROCEDURE** **Deleting designated coordinate data**

1. Select "Known data" in Memory Mode.
2. Select "Deletion" to display the list of known point data.

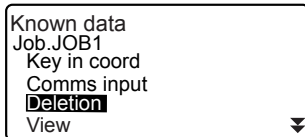

3. Select the point number to be deleted and press {←}.
 - {↑↓...P} = Use {▲} / {▼} to move from page to page.
 - {↑↓...P} = Use {▲} / {▼} to select individual point.
 - Press [TOP] to display top of point number list.
 - Press [LAST] to display end of point number list.
 - Press [SRCH] to search for point number. Input the point number after "Pt. No."
The search may take time if many data are registered.

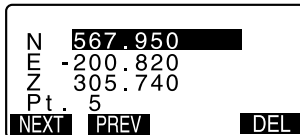

4. Press [DEL] to delete the selected point number.
 - Press [PREV] to display previous data.
 - Press [NEXT] to display next data.
5. Press {ESC} to quit the point number list and return to <Known data>.

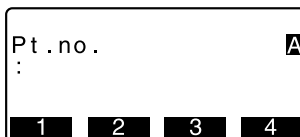

►PROCEDURE Clearing all coordinate data at once (initialization)

1. Select "Known data" in Memory Mode.
2. Select "Clear" and press {←}.
 - Current JOB name is displayed.
3. Press [YES].
<Known data> is restored.

Known data
Job.JOB1
Clear
Comms setup

C l e a r
C o n f i r m ?
NO **YES**

22.2 Reviewing Known Point Data

It is possible to display all the coordinate data within the current JOB.

►PROCEDURE

1. Select "Known data" in Memory Mode.
 - Current JOB name is displayed.
2. Select "View."
The point number list is displayed.

Known data
Job.JOB1
Key in coord
Comms input
Deletion
View

22. REGISTERING/DELETING DATA

3. Select the point number to be displayed and press **{←}**.
The coordinates of the selected point number are displayed.

```
Pt. 0 ██████████
Pt. 1
Pt. 12345678
Pt. 12345679
Pt. ██████████ SOKKIA ▾
[P] TOP LAST SRCH
```

```
N 567.950 ██████████
E -200.820
Z 305.740
Pt. 5
NEXT PREV DEL
```

4. Press **{ESC}** to restore the point number list.
Press **{ESC}** again to restore <Known data>.

22.3 Registering/Deleting Codes

It is possible to save codes in memory. You can also read in codes registered in memory when recording instrument station data or observation data.

►PROCEDURE Inputting Codes

1. Select "Code" in Memory Mode.

```
Memory
JOB
Known data
Code
```

2. Select "Key in code."
Enter the code and press **{←}**.
The code is registered and <Code> is restored.

```
Code
Key in coord
Deletion
Code view
Clear list
```



- Maximum code size: 16 (alphanumeric)
- Maximum number of codes registered: 40

```
Code A
: Pole ██████████
E F G H
```

►PROCEDURE Deleting codes

1. Select "Code" in Memory Mode.
2. Select "Deletion." The registered code list is displayed.

```
Code
Key in coord
Deletion
Code view
Clear list
```

```
Pole
A001
TREE01 LEFT
POINT01
POINT02
P TOP LAST DEL
```

3. Align the cursor with the code to be deleted and press **[DEL]**.
The designated code is deleted.
4. Press **{ESC}** to restore <Code>.



- If you select "Clear list" in step 2 and then press **[YES]**, all registered codes are deleted.

22.4 Reviewing Codes

►PROCEDURE

1. Select "Code" in Memory Mode.

22. REGISTERING/DELETING DATA

2. Select "Code view."
The registered code list is displayed.

```
Code
Key in coord
Deletion
Code view
Clear list
```

```
Pole
A001
Point 001
TREE01 LEFT
POINT01
1..P TOP LAST
```

3. Press **{ESC}** to restore <Code>.

23. OUTPUTTING JOB DATA

It is possible to output JOB data to a host computer or printer.

 Communication cables: "27.2 Optional Accessories"

Output format and command operations: "Interfacing with the SOKKIA SDR Electronic Field Book" and "Command Explanations" manuals.

- Measurement results, instrument station data, known point data, notes, and coordinate data in the JOB is output.
- Known point data entered from an external instrument is not output.
- Communication setup can be performed in the JOB menu as well. Select "Comms Setup" in <JOB>.

Caution

- When "inch" is selected as the distance unit, data is output in "feet."

► PROCEDURE Outputting JOB data to host computer

1. Connect SET and host computer.
2. Select "JOB" in Memory Mode.

```
Memory
JOB
Known data
Code
```

3. Select "Comms output" to display the JOB list.

```
JOB
JOB selection
JOB name edit
JOB deletion
Comms output
Comms setup
```

4. Select the JOB to be output and press {←→}.
"Out" appears to the right of the JOB selected. You can select as many JOBS as you want.

```
*JOB01      Out
ATUG1      254
JOB03     Out
JOB04      0
JOB05      0▼
OK
```

- "*" means the JOB has not been output to an external device yet.

5. Press [OK].

23. OUTPUTTING JOB DATA

6. Select the output format and press **{←}**.

Output starts. When the output is complete, the JOB list is restored. It is possible to continue output of the next JOB.

```
Comms output
SDR
Printed output
```

- To stop output, press **{ESC}**.

►PROCEDURE Outputting JOB data to printer

1. Select "JOB" in Memory Mode.
2. Select "Comms output" to display the JOB list.

```
JOB
JOB selection
JOB name edit
JOB deletion
Comms output
Comms setup
```

3. Select the JOB to be output and press **{←}**.
"Out" appears to the right of the JOB selected. You can select as many JOBS as you want.
4. Press **[OK]**.
5. Connect SET and printer.
6. Turn ON the printer.
7. Select "Printed output" and press **{←}**. Output starts. When the output is complete, the JOB list is restored. It is possible to continue output of the next JOB.

24. CHANGING THE SETTINGS

This section explains the contents of parameter settings, how to change settings and how to perform initialization.

24.1 Changing Instrument Options

The following explains the EDM settings and settings in Config mode. Each item can be changed to meet your measurement requirements.

- “*”: Factory setting

● EDM settings

Press **[EDM]** in the second page of Meas mode.

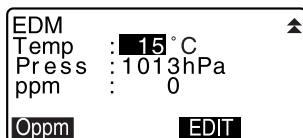
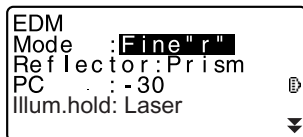

- **[EDIT]**: Sets items
- **[Oppm]**: Atmospheric correction factor returns to 0 and temperature and air pressure are set to the default values.
- Atmospheric correction factor is calculated and set using the entered values of the temperature and air pressure. Atmospheric correction factor can also be entered directly.

Caution

- "Illum. hold" is displayed only when the guide light option is mounted.

Items set, options, and input range(*: Factory setting)

Mode (Distance measurement Mode): Fine "r"*, Fine AVG (Setting: 1 to 9 times), Fine "s", Rapid "s", Tracking

Reflector: Prism* / Sheet / None (reflectorless)

PC (Prism constant): -99 to 99 mm ("Prism" is selected: -30*, "Sheet" is selected: 0*)

24. CHANGING THE SETTINGS

Temp. (Temperature): -30 to 60°C (15°)

Air pressure: 500 to 1400hPa (1013*), 375 to 1050mmHg (760*)

ppm (Atmospheric correction factor): -499 to 499 (0*)

Illum. hold: Laser (laser sight)* / Guide (Guide light)



- The screen will be displayed only when "Illum. hold " is set to "Guide" and the cursor is on "Guide".

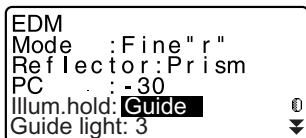

Item set and option (*: Factory setting)

The Guide light (Brightness level of the guide light): 1 to 3 (3*)



Atmospheric correction factor

The SET measures the distance with a beam of light, but the velocity of this light varies according to the index of refraction of light in the atmosphere. This index of refraction varies according to the temperature and air pressure.

- To precisely determine the atmospheric correction factor, the average temperature and air pressure along the measurement beam route must be taken. Take care when calculating the correction factor in mountainous terrain as the difference in height will result in differences in atmospheric conditions between two points.
- The SET is designed so that the correction factor is 0 ppm at an air pressure of 1013 hPa and a temperature of 15°C.
- By inputting the temperature and air pressure values, the atmospheric correction value is calculated and set into the memory. Calculate the atmospheric correction factor as shown in the following formula.

$$\text{ppm} = 282.59 - \frac{0.2942 \times \text{air pressure (hPa)}}{1 + 0.003661 \times \text{air temperature (}^\circ\text{C)}}$$

"30.2 Atmospheric Correction for High Precision Distance Measurement"

- If the weather correction is not required, set the ppm value to 0.



Prism constant correction

Reflective prisms each have their prism constant.

Set the prism constant correction value of the reflective prism you are using. When selecting "None (Reflectorless)" in "Reflector", prism constant correction value is set to "0" automatically.

- The following are samples of the prism constant correction values of reflective prisms from Sokkia.

AP01S+AP01 (Constant = 30mm)

AP01 (Constant = 40mm)

CP01 (Constant = 0mm)

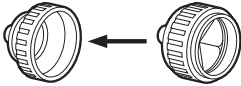

Correction Value = -30



Correction Value = -40



Correction Value = 0

● **Settings in Config Mode**

Select "Obs. condition" in Config mode

```
Dist mode: Sdist
Tilt crn  : Yes(H,V)
coll.crn  : Yes
C&R crn.  : No
V manual  : No
V. obs    : Zenith
```

```
Ang. reso. : 5"
Coord.     : N-E-Z
```

Items set and options (*: Factory setting)

Dist mode: Sdist*, Hdist, Vdist

Tilt crn (Tilt angle compensation): Yes(H,V)*, Yes(V), No

coll. crn (Collimation correction): Yes*, No

C&R crn.: No*, K=0.142, K=0.20

V manual: Yes, No*

V.obs (Vertical angle display method): Zenith*, Horiz, Horiz 90° (Horizontal ±90°)

Ang. reso. (Angle resolution): SET230R/330R/530R:1", 5", SET630R:1", 5"*

Coord.: N-E-Z*, E-N-Z

24. CHANGING THE SETTINGS



Automatic tilt angle compensation mechanism

The vertical and horizontal angles are automatically compensated for small tilt errors using the 2-axis tilt sensor.

- Read the automatically compensated angles when the display has stabilized.
- The horizontal angle error (vertical axis error) fluctuates according to the vertical axis, so when the instrument is not completely leveled, changing the vertical angle by rotating the telescope will cause the displayed horizontal angle value to change.

Compensated horizontal angle = Measured horizontal angle + Tilt in angle / tan (Vertical angle)

- When the telescope is directed close to the zenith or nadir angle, tilt compensation is not applied to the horizontal angle.



Collimation correction

The SET has a collimation correction function that automatically corrects horizontal angle errors caused by horizontal axis and leveling axis errors.



V obs. (vertical angle display method)

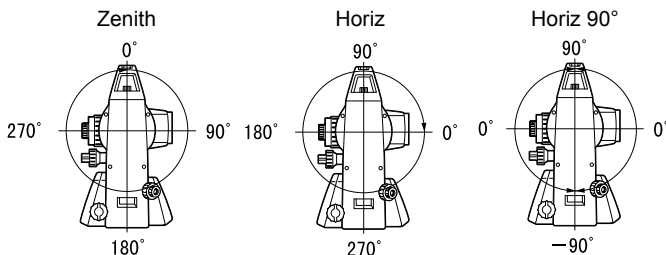

Select "Instr. Config" in Config mode

Power off	: 30min
Reticle lev	: 3
Contrast	: 10
Resume	: Of f
EDM ALC	: Hold
Guide pattern	: 1

Caution

- "Guide pattern" is displayed only when the guide light option is selected.

Items set and options (*: Factory setting)

Power off: 5min, 10min, 15min, 30min*, No

Reticle lev: 0 to 5 level (3*)

Contrast: 0 to 15 level (10*)

Resume: On, Off*

EDM ALC: Hold*, Free

Guide pattern: 1 (the red and green lights flash simultaneously)* / 2 (the red and green lights flash alternately)

**Power-saving automatic cut-off**

To save power, power to the SET is automatically cut off if it is not operated for the selected time.

**Resume function**

When the Resume function is set to "On," and the power is switched off and then on again, the screen appearing before the instrument was switched off is redisplayed. Also, all parameter settings are saved. Memory backup period is about one week, after which the Resume function is cancelled.

**EDM ALC**

Set the light receiving status of the EDM. While carrying out continuous measurement, set this item according to the measurement conditions.

- When EDM ALC is set to "Free," the amount of light received is adjusted by the instrument's EDM ALC. Set to "Free" when the target is moved during measurement or different targets are used.
- When "Hold" is set, the amount of light received remains fixed until continuous measurement is completed.
- If an obstacle intermittently obstructs the light beam during continuous measurement and the "Signal off" error occurs, each time the obstruction occurs it takes some time for the amount of light received to be adjusted and the measurement value displayed. Set to "Hold" when the light beam used for measurement is stable but is frequently obstructed by obstacles such as people, cars, or tree branches etc.



The EDM ALC setting will automatically be switched to "Free" when the distance measurement mode is set to "Tracking" (target is moved during distance measurement).

24. CHANGING THE SETTINGS

Select "Comms setup" in Config mode

Baud rate:	9600bps
Data bits:	8bit
Parity :	Not set
Stop bit :	1bit
Check sum:	No
Xon/Xoff :	Yes

Items set and options (*: Factory setting)

Baud rate: 1200bps*, 2400bps, 4800bps, 9600bps, 19200bps, 38400bps

Data bits: 8bit*, 7bit

Parity: Not set*, Odd, Even

Stop bit: 1bit*, 2bit

Check sum: Yes, No*

Xon/Xoff: Yes*, No

 Output format and command operations: "Interfacing with the SOKKIA SDR Electronic Field Book" and "Command Operations" manuals.

Select "Unit" in Config mode

Temp.	: °C
Press.	: hPa
Angle	: degree
Dist	: meter

Items set and options (*: Factory setting)

Temp. (Temperature): °C*, °F

Press.: hPa*, mmHg, inchHg

Angle: degree*, gon, mil

Dist: meter*, feet, inch



Inch (Fraction of an inch)

“Fraction of an inch” is the unit used in the United States and expressed like the following example.

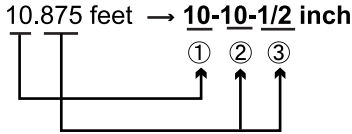

- ① 10.000 feet
- ② 0.875 feet x 12=10.5 inch
- ③ 0.5 inch=1/2 inch

Caution

- Even if “inch” is selected in this setting, all the data including the result of area calculation are output in “feet” and all the distance values must be input in “feet”. In addition, when the “inch” display exceeds the range, it is displayed in “feet”.

24.2 Allocating Key Functions

It is possible to allocate the softkeys in Meas mode to suit the measurement conditions. It is possible to operate the SET efficiently because unique softkey allocations can be preset to suit various applications and the ways that different operators handle the instrument.

- The current softkey allocations are retained until they are revised again, even when the power is cut off.
- It is possible to register two sets of key function allocations: user setting 1 and user setting 2.
- It is possible to recall the softkey arrays registered for User 1 and User 2 as necessary.

Caution

- When softkey allocations are recorded and registered, the previously recorded key settings are cleared. When a softkey array is recalled, the key array is changed to the key array that has been recalled, clearing the previous key array. Be sure to remember this.

● The following are the softkey allocations when the SET was shipped.

Page 1 [DIST] [▲ SHV] [0SET] [COORD]

Page 2 [MENU] [TILT] [H.ANG] [EDM]

Page 3 [MLM] [OFFSET] [REC] [S-O]

● The following functions can be allocated to the softkeys.

[DIST] : Distance measurement

[▲ SHV] : Switch between angle display and distance display

[0SET] : Set horizontal angle to 0

[COORD] : Coordinates measurement

[REP] : Repetition measurement

[MLM] : Missing line measurement

[S-O] : Setting-out measurement

[OFFSET] : Offset measurement

[REC] : To Record menu

[EDM] : Setting EDM

[H.ANG] : Set required horizontal angle

[TILT] : Display tilt angle

[MENU]	: To Menu mode (Coordinates measurement, setting-out measurement, offset measurement, repetition measurement, missing line measurement, REM measurement, resection measurement, surface area measurement, set-out line, point projection)
[REM]	: REM measurement
[RESEC]	: Resection measurement
[R/L]	: Select horizontal angle right/left
[ZA / %]	: Switch between zenith angle/slope in %
[HOLD]	: Hold horizontal angle/release horizontal angle
[RCL]	: Display final measurement data
[D_OUT]	: Output measurement results to an external instrument
[AIM]	: Return signal
[AREA]	: Surface area measurement
[F/M]	: Switch between meters/feet
[HT]	: Set the instrument station height and target height
[S-O LINE]	: Setting-out line measurement
[P-PROJ]	: Point projection measurement
[---]	: No functions set

● Softkey Allocation Examples

It is possible to allocate the same key to each page (example 1). The same function can be allocated to more than one key on the same page (example 2). And it is also possible to allocate a function to only one key (example 3).

Allocation example 1:

P1 **[DIST]** **[▲ SHV]** **[H.ANG]** **[EDM]**

P2 **[DIST]** **[▲ SHV]** **[H.ANG]** **[EDM]**

Allocation example 2:

P1 **[DIST]** **[DIST]** **[▲ SHV]** **[▲ SHV]**

Allocation example 3:

P1 **[DIST]** **[▲ SHV]** **[---]** **[---]**

►PROCEDURE Allocating functions

1. Select "Key function" in Config Mode.
Select "Define." Currently allocated softkeys are displayed in <Key function>.
2. Align the cursor with the softkeys whose allocation you want to change using {▶} / {◀}.
The cursor of the selected softkey flashes.
3. Change the softkey function using {▲} / {▼}.
Set the softkey function and its location by pressing {▶} / {◀}. The set softkey stops flashing and the cursor flashes on the next softkey.
4. Repeat steps 2 to 3 only as many times as necessary.
5. Press [OK] to record the allocations and restore <Key function>.
The functions with their new allocations are displayed in Meas mode.

Key function			
DIST	SHV	0SET	COORD
MLM	S-O	OFFSET	REM
EDM	H.ANG	TILT	MENU
			OK

►PROCEDURE Registering an allocation

1. Allocate functions to the softkeys.
 "PROCEDURE Allocating functions"
2. Select "key function" in Config mode.

3. Select "Registration."
Select either "User 1" or "User 2" as the softkey array to be registered.
4. Press {←}. The softkey array is registered as user 1 or user 2 and <Key function> is restored.

```

Key function
User's 1
User's 2

Registered to 1
    
```

► **PROCEDURE Recalling an allocation**

1. Select "Key function" in Config Mode.
2. Select "Recall." Select the key array for either User 1, User 2, or Default (setting when the SET was shipped), and press {←}. <Key function> is restored. This displays the functions in the recalled array in Meas mode.

```

Key function
User's 1
User's 2
Default
    
```

24.3 Changing Password

Set password can be changed.

- No password was set when the SET was shipped.

► **PROCEDURE Changing password**

1. Select "Change Password" in Config mode.
2. Input old password and press {←}.

```

Change password
Old password
:*****

1  2  3  4
    
```

24. CHANGING THE SETTINGS

3. Input new password twice and press {←}. The password is changed and <Config> is restored.
 - If no password was input as new password and {←} was pressed, no password is set.



- Input range of password: 3 or more characters and 8 or fewer characters

24.4 Restoring Default Settings

The following explains the two methods of restoring default settings: Restoring set items to initial settings and turning power on. Initializing the data and turning power on.

- Restore the following items to the initial settings when the SET was shipped.
EDM setting, Config mode settings (including softkey arrays)
- About initial settings when the SET was shipped, "24.1 Changing Instrument Options", "24.2 Allocating Key Functions".
- Initialize the data. The following data is initialized.
Data within all jobs
Known point data within memory
Code data within memory

►PROCEDURE Restoring set items to initial settings and turning power on

1. Turn the power off.
2. While pressing **{F4}** and **{BS}**, press **{ON}**.
3. The SET is turned on, "Default set" appears on the screen and all items are restored to their initial settings.

►PROCEDURE Initializing the data and turning the power on

1. Turn the power off.
2. While pressing **{F1}**, **{F3}** and **{BS}**, press **{ON}**.
3. The SET is turned on, "Clearing memory..." appears on the screen and all items are restored to their initial settings.

25. WARNING AND ERROR MESSAGES

The following is a list of the error messages displayed by the SET and the meaning of each message. If the same error message is repeated or if any message not shown below appears, the instrument has malfunctioned. Contact your Sokkia agent.

Bad condition

The air is shimmering a lot, etc., measuring conditions are poor.

The center of the target cannot be sighted.
Resight the target.

Unsuitable distance measurement conditions when reflectorless measurement is set. When reflectorless measurement is set, distance cannot be measured because the laser beam is striking at least two surfaces at the same time.
Choose a single surface target for distance measurement.

Calculation error

Coordinates identical to the known point coordinates observed during resection exist. Set another known point so that the known point coordinates do not coincide.

Checksum error

A sending / repetition error has occurred between the SET and external equipment.
Send / receive the data again.

Communication error

A reception error has occurred in coordinate data from an external instrument.
Check the settings of parameters concerning communication conditions.
 "24.1 Changing Instrument Options ● Settings in Config Mode"

Flash write error!

Flash mount error!

It is impossible to read in data.
Contact your Sokkia agent.

Incorrect Password

Input password does not match set password. Input correct password.

Invalid baseline

During setting-out line measurement or point projection measurement, baseline has not been defined correctly.

Memory is full

There is no more room to enter data.

Record the data again after deleting unnecessary data from the JOB or coordinate data from the memory.

Need 1st obs

During missing line measurement, the observation of the starting position was not completed normally.

Sight the starting position accurately and press **[OBS]** to perform the measurement again.

Need 2nd obs

During missing line measurement, the observation of the target was not completed normally.

Sight the target accurately and press **[MLM]** to perform the measurement again.

Need offset pt.

Observation of the offset point during offset measurement was not completed normally.

Sight the offset point accurately and press **[OBS]** to perform the measurement again.

Need prism obs

During REM measurement, the observation of the target was not completed normally.

Sight the target accurately and press **[OBS]** to perform measurement again.

New password Diff.

During new password setting, the passwords input twice are different. Input new password twice correctly.

No data

When searching for or reading in coordinate data or searching for code data, the search stopped either because the item in question does not exist or the data volume is large.

No solution

The calculation of the instrument station coordinates during resection does not converge.

Assess the results and if necessary, perform the observation again.

25. WARNING AND ERROR MESSAGES

Out of range

The tilt of the instrument exceeds the tilt angle compensation range during measurement.

Sight again within $\pm 3'$.

Out of value

During gradient % display, the display range (less than $\pm 1000\%$) has been exceeded.

During REM measurement, either the vertical angle has exceeded horizontal $\pm 89^\circ$ or the measured distance is greater than 9999.999m.

Install the instrument station far from the target.

The instrument station coordinates calculated during resection are too high. Perform the observation again.

During setting-out line measurement, scale factor has been less than 0.100000 or exceeded 9.999999.

Print or send first

JOB data output (transmission to the host computer or output to the printer) is not completed before JOB is cleared.

Either transmit the JOB to be cleared to the host computer or output it to the printer.

RAM cleared

(Displayed when the SET is switched on) The resume function does not work because more than one week (memory back-up period) has passed since the SET was last switched off.

After more than one week, even though "Resume" is still set to "On," the resume function has been canceled.

Same coordinates

The same values are input in Pt.1 and Pt.2 in setting-out line measurement. SET cannot define the baseline.

Signal off

Measuring conditions are poor, and there is not any reflective light for measuring distances.

Resight the target. When using reflective prisms, effectiveness will be improved by increasing the number of prisms used.

Temp Rnge OUT

SET is outside useable temperature range and accurate measurement cannot be performed. Repeat measurement within the appropriate temperature range. If the SET is used under direct sunlight, use an umbrella to protect it against the heat of the sun.

Time out

Measuring conditions are poor, and due to the insufficient amount of reflective light, measuring could not be carried out within the time specified.

Resight the target. When using reflective prisms, effectiveness will be improved by increasing the number of prisms used.

Too short

Input password has fewer than 3 characters. Password must have 3 or more characters and 8 or fewer characters.

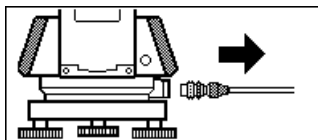

If the printer cable is attached during measurement, measurement cannot be carried out correctly. SET notifies you by displaying the screen above and beeping. When the cable is removed, the previous screen is restored.

If connected SDR or host computer is turned Off, the above screen appears. This is normal, and does not indicate trouble. If connected SDR or host computer is turned On again or cable is connected again, the previous screen is restored.

26. CHECKS AND ADJUSTMENTS

A SET is a precision instrument that requires fine adjustments. It must be inspected and adjusted before use so that it always performs accurate measurements.

- Always perform checking and adjustment in the proper sequence beginning from "26.1 Plate Level" to "26.8 Guide Light".
- In addition, the instrument should be inspected with special care after it has been stored a long time, transported, or when it may have been damaged by a strong shock.

26.1 Plate Level

The bubble tube is made of glass, so it is sensitive to temperature changes or to shock. Check and adjust it as outlined below.

►PROCEDURE Checking and adjusting

1. Level the instrument and check the position of the bubble of the plate level.
☞ "7.2 Levelling", steps 3 to 5.
2. Turn the upper part through 180° and check the bubble position. If the bubble is still centered, no adjustment is necessary. If the bubble is off-center, adjust as follows.
3. Correct half of the bubble displacement using levelling foot screw C.

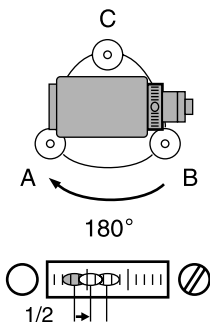

- Correct the remaining half of the displacement by using the adjustment pin to rotate the plate level adjustment screw. When the plate level adjustment screw is turned in the counterclockwise direction, the bubble moves in the same direction.
- Rotate the top of the instrument and continue adjustments until the bubble remains centered for any position of the upper part. If the bubble does not move to the center even when the adjustment has been repeated, ask your Sokkia agent to adjust it.

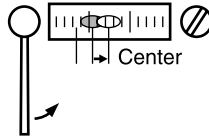

26.2 Circular Level

►PROCEDURE Checking and adjusting

- Perform the plate level inspection and adjustment or carefully use the plate level to level the instrument.
☞ "7.2 Levelling", steps 1 to 2.
- Check the position of the bubble of the circular level.
If the bubble is not off-center, no adjustment is necessary.
If the bubble is off-center, perform the following adjustment.

26. CHECKS AND ADJUSTMENTS

3. First confirm the off-center direction.
Use the adjusting pin to loosen the circular level adjustment screw on the side opposite to the direction the bubble is displaced to move the bubble to the center.

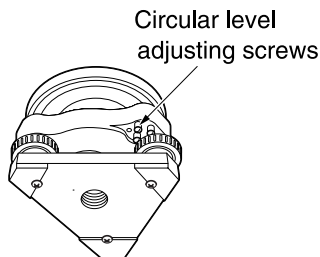

4. Adjust the adjusting screws until the tightening tension of the three screws is the same to align the bubble in the middle of the circle.

Caution

- Be careful that the tightening tension is identical for all the adjusting screws.
- Also, do not over-tighten the adjusting screws as this may damage the circular level.

26.3 Tilt Sensor

If the tilt angle shown on the display shifts from tilt angle 0° (zero point), the instrument is not correctly levelled. This will adversely affect angle measurement. Perform the following procedure to cancel the tilt zero point error.

►PROCEDURE Check

1. Carefully level the instrument. If necessary, repeat the procedures to check and adjust the bubble levels.
2. Set the horizontal angle to 0° .
Press **[0set]** twice in the first page of the Meas mode screen to set the horizontal angle to 0° .

3. Select "Instr. const" in the Config. mode screen to display the current correction constant in the X (horizontal) direction and Y (vertical) direction.

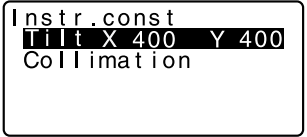
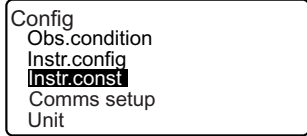

Select "Tilt X Y" press {←} to display the tilt angle in the X (sighting) direction and Y (horizontal axis) direction.

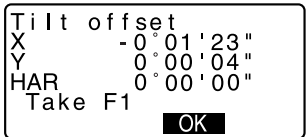

4. Wait a few seconds for the display to stabilize, then read the automatically compensated angles X1 and Y1.

5. Rotate the top of the instrument through 180°. Loosen the horizontal clamp and turn the instrument 180° while referring to the displayed horizontal angle, then retighten the clamp.

6. Wait a few seconds for the display to stabilize, then read the automatically compensated angles X2 and Y2.

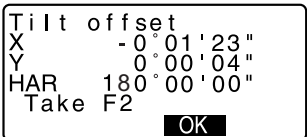

7. In this state, calculate the following offset values (tilt zero point error).
 $X_{\text{offset}} = (X1+X2)/2$
 $Y_{\text{offset}} = (Y1+Y2)/2$

26. CHECKS AND ADJUSTMENTS

If one of the offset values (Xoffset, Yoffset) exceeds $\pm 20''$, adjust the value using the following procedure.

When the offset value falls within the range $\pm 20''$, adjustment is not necessary.

Press **{ESC}** to return to <Instr. const>.

►PROCEDURE Adjustment

8. Store values X2 and Y2
Press **[OK]** to set the horizontal angle to 0°. "Take F2" is displayed.
9. Rotate the top of the instrument through 180°.
10. Wait a few seconds for the display to stabilize, then store the automatically compensated angles X1 and Y1.
Press **[YES]** to store tilt angles X1 and Y1. The new correction constant is displayed.
11. Confirm that the values are in the adjustment range.
If both correction constant are within the range 400 ± 30 , select **[YES]** to renew the correction angle. <Instr. const> is restored. Continue to step 12.
If the values exceed the adjustment range, select **[NO]** to cancel the adjustment and restore <Instr. const>. Contact your Sokkia agent to perform the adjustment.

Tilt offset		
Current	X400	Y400
New	X408	Y396
		NO YES

►PROCEDURE Recheck

12. Press {←} at <Instr. const>.
13. Wait a few seconds for the display to stabilize, then read the automatically compensated angles X3 and Y3.
14. Rotate the top of the instrument through 180°.
15. Wait a few seconds for the display to stabilize, then read the automatically compensated angles X4 and Y4.
16. In this state, the following offset values (tilt zero point error) are calculated.
 $X_{\text{offset}} = (X3+X4)/2$
 $Y_{\text{offset}} = (Y3+Y4)/2$
When both offset values fall within the range $\pm 20''$, adjustment is completed.
Press {ESC} to return to <Instr. const>.

If one of the offset values (X_{offset} , Y_{offset}) exceeds $\pm 20''$, repeat the check and adjustment procedures from the beginning. If the difference continues to exceed $\pm 20''$ after repeating the check 2 or 3 times, have your Sokkia agent perform the adjustment.

26.4 Collimation

With this option you can measure collimation error in your instrument so that the SET can correct subsequent single face observations. To measure the error, make angular observations using both faces.

► Procedure

1. Display <Collimation>. Select "Instr.const" in the Config. mode screen and select "Collimation"
2. Sight the reference point in Face 1.
Sight the reference point in Face 1 and press **[OK]**.
3. Sight the reference point in Face 2.
Rotate the instrument 180°. Sight the same point in Face 2 and press **[OK]**.
4. Set the constant.
Press **[YES]** to set the constant.
 - Press **[NO]** to discard the data and return to <Collimation>.

Collimation	
EL :	-0°00'15"
V off.:	0°00'10"
<input type="checkbox"/> NO <input checked="" type="checkbox"/> YES	

26.5 Reticle

► PROCEDURE Check 1: Perpendicularity of the reticle to the horizontal axis

- Carefully level the instrument.
- Align a clearly visible target (the edge of a roof for example) on point A of the reticle line.

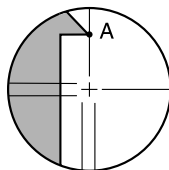

- Use the telescope fine motion screw to align the target to point B on a vertical line.

If the target moves parallel to the vertical line, adjustment is unnecessary. If its movement deviates from the vertical line, have your Sokkia service representative adjust it.

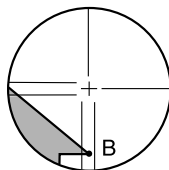

► PROCEDURE Check 2: Vertical and horizontal reticle line positions

Caution

- Perform the check procedure under slightly hazy and weakly scintillating conditions.
- Install a target at a point about 100m in the horizontal direction from the SET.
 - Level the instrument carefully, turn on the instrument's power.



3. While the Meas mode screen is displayed and the telescope is in face left, sight the center of the target and read out the horizontal angle A1 and the vertical angle B1.

Example: Horizontal angle A1=18° 34' 00"

Vertical angle B1=90° 30' 20"

4. While the telescope is in face right, sight the center of the target and read out the horizontal angle A2 and the vertical angle B2.

Example: Horizontal angle A2=198° 34' 20"

Vertical angle B2=269° 30' 00"

5. Do the calculations:

A2-A1 and B2+B1

If A2-A1 is within $180^{\circ} \pm 20''$ and B2+B1 is within $360^{\circ} \pm 40''$, adjustment is unnecessary.

Example: A2-A1 (Horizontal angle)

=198° 34' 20" - 18° 34' 00"

=180° 00' 20"

B2-B1 (Vertical angle)

=269° 30' 00" + 90° 30' 20"

=360° 00' 20"

If the difference is large even after repeating the check 2 or 3 times, have your Sokkia service representative perform the adjustment.

26.6 Optical Plummet

►PROCEDURE Checking

1. Carefully level the SET and center a surveying point precisely in the reticle of the optical plummet.
2. Turn the upper part through 180° and check the position of the surveying point in the reticle. If the surveying point is still centered, no adjustment is necessary. If the surveying point is no longer centered in the optical plummet, perform the following adjustment.

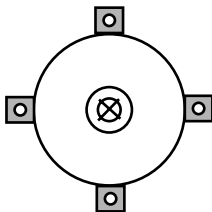

►PROCEDURE Adjustment

3. Correct half the deviation with the levelling foot screw.
4. Remove the optical plummet reticle cover.

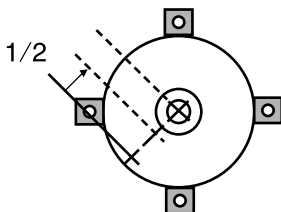

5. Use the 4 adjusting screws of the optical plummet to adjust the remaining half of the deviation as shown below.

When the surveying point is on the lower (upper) part of the illustration:

Loosen the upper (lower) adjusting screw slightly, and tighten the upper (lower) adjusting screw the same amount to move the surveying point to a point directly under the center of the optical plummet.

(It will move to the line in the figure on the right.)

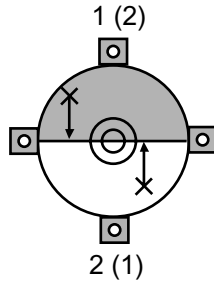

If the surveying point is on the solid line (dotted line):

Loosen the right (left) adjusting screw slightly and, tighten the left (right) adjusting screw by the same amount to move the surveying point to a point in the center of the optical plummet.

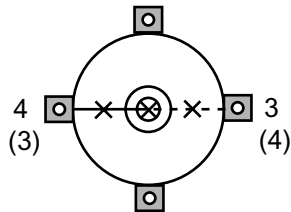

Caution

- Be extremely careful to adjust all the adjustment screws by the same amount so that none will be over-tightened.

6. Check to make sure that the surveying point remains centered on the reticle even if the upper part of the instrument is rotated. If necessary, perform the adjustment again.

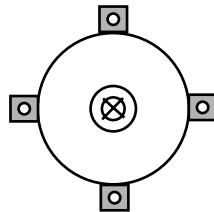

7. Replace the optical plummet reticle cover.

26.7 Additive Distance Constant

The additive distance constant K of the SET is adjusted to 0 before delivery. Although it almost never deviates, use a baseline with a known distance precision to check that the additive distance constant K is close to 0 several times a year and whenever the values measured by the instrument begin to deviate by a consistent amount. Perform these checks as follows.

Caution

- Errors in setting up the instrument and reflective prism or in sighting the target will influence the additive distance constant. Be extremely careful to prevent such errors when performing these procedures.
- Set up so that the instrument height and the target height are identical. If a flat place is not available, use an automatic level to make sure the heights are identical.

►PROCEDURE Check

1. Find an area of flat ground where two points 100m apart can be selected.

Set up the Instrument at point A and the reflective prism at point B. Establish a point C half way between points A and B.

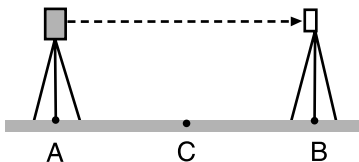

2. Precisely measure the horizontal distance between point A and point B 10 times and calculate the average value.

3. Place the SET at point C directly between points A and B and set up the reflective prism at point A.

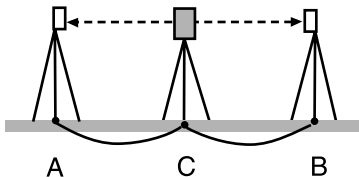

4. Precisely measure the horizontal distances CA and CB 10 times each and calculate the average value for each distance.

5. Calculate the additive distance constant K as follows.

$$K = AB - (CA+CB)$$
6. Repeat steps 1 to 5 two or three times.
 If the additive distance constant K is within $\pm 3\text{mm}$ even once, adjustment is unnecessary.
 If it always exceeds this range, have your Sokkia service representative perform an adjustment.

26.8 Guide Light

When the dividing line (the position where it switches back and forth from red to green) for the red and green guide lights is off centered from the reticle lines, use the following procedures to make adjustments.

Caution

- The guide light is an optional function. Set "Illum. Hold" to "Guide" in Config. mode, Use the setting page to select, check and adjust the guide light.
 [☞] "24.1 Changing Instrument Options, ● EDM settings" and "27.2 Optional Accessories"

►PROCEDURE Checks

1. Install a prism at a point about 20 meters in the horizontal direction from the SET.
2. Level the instrument.
3. Sight the center of the prism with the telescope (face left).



26. CHECKS AND ADJUSTMENTS

4. Hold  down to turn the guide lights on.
5. Set the horizontal angle to 0° by pressing **[0 SET]** twice on the first page of the Meas mode.
6. Look through the telescope to verify that the guide lights are being reflected in the prism.

If both colors (red and green) are visible: proceed to procedure 7.

If only the red or the green are visible: proceed to procedure 10.

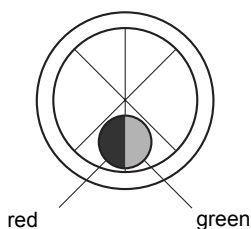

7. Move the top of the instrument slightly while looking through the telescope, measure the horizontal angle of the position that changes only to green from both colors (red and green) of the guide light colors that are reflected in the prism.
8. Move the top of the instrument slightly while looking through the telescope, measure the horizontal angle of the position that changes only to red from both colors (red and green) of the guide light colors that are reflected in the prism.

9. Calculate the difference of the angle of the horizontal angle to search for the offset direction of the dividing line of the guide lights from the measurement values of procedures 7 and 8.

Example:

(Procedure 7) The horizontal angle $0^{\circ}03'30'' = 04'30''$ to the right from the reticle line ($=0^{\circ}$ set position) of the position that changes to green only from both colors (red and green) of the colors of the guide lights that are reflected in the prism.

(Procedure 8) The horizontal angle $359^{\circ}57'00'' = 03'00''$ to the left from the reticle line ($=0^{\circ}$ set position) of the position that changes to green only from both colors (red and green) of the colors of the guide lights that are reflected in the prism.

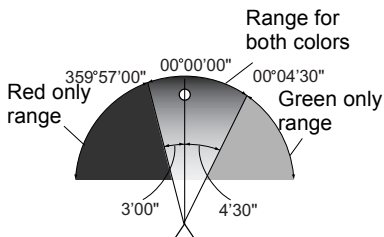

- The angle difference for procedures 7 and 8 is $1'30''$, with this the dividing line for the green and the red shifts to the right side (the green side).

Note

The illustration depicts how the left and right colors of the guide light are reflected in a prism and seen when viewed through the telescope.

When the angle difference is more than $1'$, proceed to the adjustments for procedure 10.

26. CHECKS AND ADJUSTMENTS

When the angle difference is less than $1'$, adjustments are unnecessary.

►PROCEDURE Adjustments

10. Adjust the dividing line for the red and green lights of the guide lights that are reflected in the prism so that it is centered in the reticle.
When only the red is visible, or if the dividing line shifts onto the red side: turn the guide light adjustment screw clockwise.
When only the green is visible, or if the dividing line shifts onto the green side: turn the guide light adjustment screw counterclockwise.

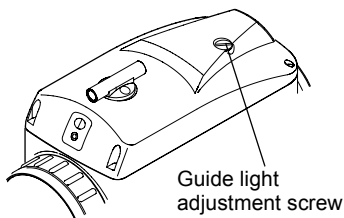

11. Carry out a check of procedures 7 to 9 once again.
When the measurement value difference for the horizontal angle is more than $1'$, then repeat the adjustments for procedure 10.
When the measurement value difference for the horizontal angle is less than $1'$, then adjustments are complete.

27. STANDARD EQUIPMENT AND OPTIONAL ACCESSORIES

27.1 Standard Equipment

- Please verify that all equipment is included.

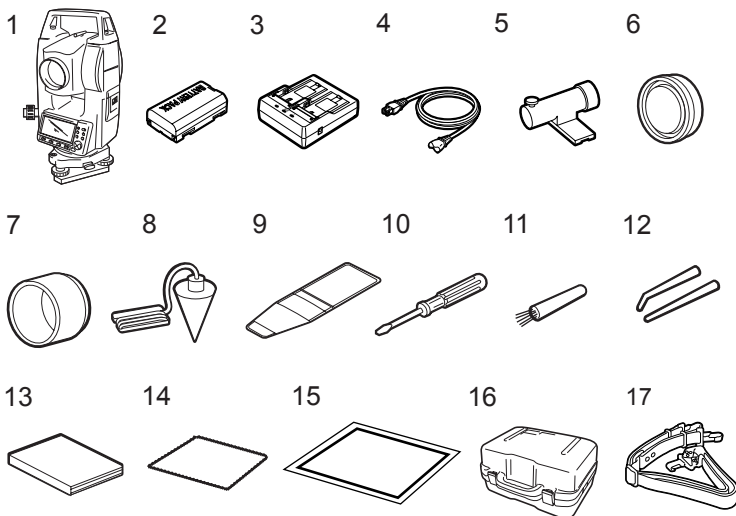

1	SET main unit	1	10	Screwdriver	1
2	Battery (BDC46A) (SET230R/330R/530R)	2	11	Lens brush	1
	(SET630R)	1	12	Adjusting pin	2
3	Battery charger (CDC68)	1	13	Operator's manual	1
4	Power cable (EDC113A/113B/113C)	1	14	Wiping cloth	1
5	Tubular compass(CP7)	1	15	Laser caution sign-board (class3R/IIIa) (only SET230R3/ 330R3/530R3)	1
6	Lens cap	1	16	Carrying case (SC196)	1
7	Lens hood	1	17	Carrying straps	1
8	Plumb bob	1			
9	Tool pouch	1			

● Tubular compass (CP7)

Slide the tubular compass into the tubular compass slot, loosen the clamp screw, then rotate the top part of the instrument until the compass needle bisects the index lines. The telescope's face left sighting direction in this position will indicate magnetic north. After use, tighten the clamp and remove the compass from the slot.

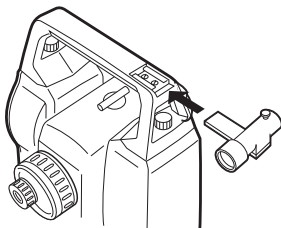

Caution

- The tubular compass is susceptible to the influence of nearby magnets or metal. Such influence could cause it to fail to accurately indicate magnetic north. Do not use magnetic north as indicated by this compass for base line surveying.

● Plumb bob

The plumb bob can be used to set up and center the instrument on days when there is little wind. To use the plumb bob, unwind its cord, pass it through the cord grip piece as shown in the figure to adjust its length, then suspend it from the hook attached to the centering screw.

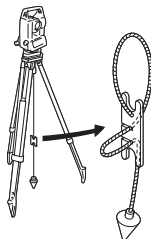

● Handle

The carrying handle can be removed from the instrument. To remove it, loosen the handle securing screw

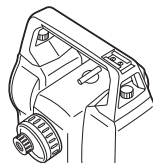

27.2 Optional Accessories

The following are optional accessories which are sold separately from the SET.
 ☞ Target and power supply optional accessories: "27.3 Target System", and "27.4 Power Supply System".

● Wireless keyboard (SF14)

For SET230R/330R/530R
 SF14 makes measuring operation and inputting data easier and speedier.

☞ Location of operation keys on the wireless keyboard: "4.1 Parts of the Instrument", operation: "5.1 Basic Key Operation"

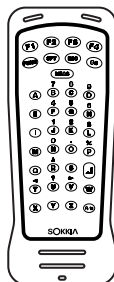

Interface: Modulated infrared LED
 Power source: R03/AAA × 2(3V DC)
 Operating range: within 2m
 (operating range may vary with different operating conditions)
 Keyboard: 37 keys
 Operating temperature: -20 to 50°C
 Dust and water resistance: IP44 (IEC60529: 1989)
 Size: 162 (W) × 63 (D) × 19 (H) mm
 Weight: about 120g (with battery cells)



Changing battery cells

Caution

- Be sure to replace all battery cells at the same time.
- Either all alkaline or all manganese batteries should be used.
- Remove the battery cells when the keyboard is not to be used for a long time.

27. STANDARD EQUIPMENT AND OPTIONAL ACCESSORIES

1. Hold the Wireless Keyboard with the Battery Cover facing toward you.
2. Insert the edge of a coin into the Notch on the Battery Cover and push down the coin to lift up the cover.

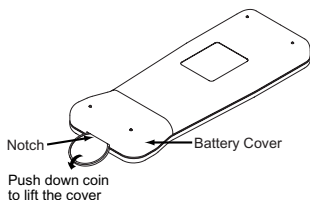

3. Gently twist the coin to open the cover.

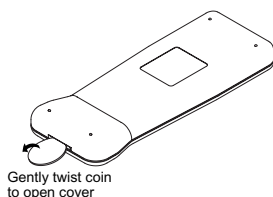

4. Mount two battery cells (R03/AAA). The direction of the batteries is indicated in the battery compartment.

5. Align the straight edge of the cover with the straight edge of the battery compartment. Press down on the areas indicated by the arrows in the illustration below to close the cover.

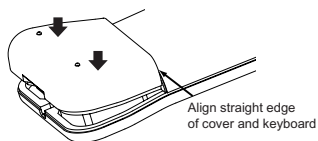

● Guide light (GDL1)

Setting-out measurements etc. can be carried out effectively using the Guide light. The Guide light is composed of a light that is divided into a red and green.

- ☞ Guide light status: "4.1 Parts of the Instrument", guide light ON/OFF: "5.1 Basic Key Operation"

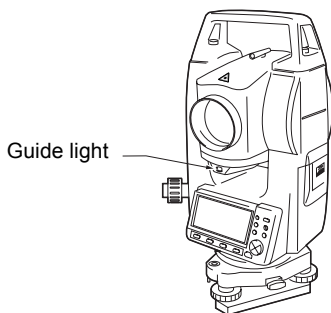

(Slight haze, visibility about 20 km,
sunny periods, weak scintillation)

Light source: LED (red 626 nm/ green
524 nm) (Class 1
IEC60825-1/2001)

Distance: 1.3 to 150m

Visible range:

Right and left: about $\pm 4^\circ$, about 7m
(100m)

Upward and downward:
about $\pm 4^\circ$, about 7m
(100m)

Resolving power at center area (width):
less than about 0.12m
(100m)

● Sideplate with card slot (SCRC2A)

For SET230R/330R/530R

It has CF card slot.

 For details, see "Series 30R
Operator's manual (Additional
Function) Card Mode"

● Telescope eyepiece lens (EL6)

For SET 630R

Magnification: 30X

● Telescope eyepiece lens (EL7)

Magnification: 40X

Field of view: 1° 20'

● Battery Unit (BDC55)

● Laser Plummet (LAP1)

When using the LAP1, a laser is emitted from the bottom of the main unit marking it easier to position the instrument over the surveying point. The BDC55 is the power source for the LAP1. The buttons on the BDC55 can also be used to operate the LAP1.

27. STANDARD EQUIPMENT AND OPTIONAL ACCESSORIES

● Diagonal eyepiece (DE25)

The diagonal eyepiece is convenient for observations near the nadir and in narrow spaces.
Magnification:30X

After removing the handle from the SET, loosen the attachment screw to remove the telescope eyepiece. Then screw the diagonal lens into place.

 Handle removal method:
"27.1 Standard Equipment"

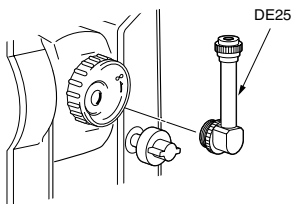

● Solar filter (OF3A)

When sighting targets where glare is present, solar observations for example, attach it to the objective lens of the SET to protect its interior and the eyes of its operator. The filter part can be flipped up without being removed.

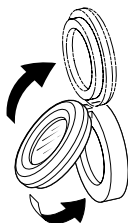

● Printer cable (DOC46)

The SET can be connected to a Centronics specification printer which supports ESC/PTM by the printer cable DOC46. This allows direct output of data from the SET to a printer.



● Interface cable

Connect between the SET and the host computer for data output.

Computer	Cable	Notes
IBM PC/AT or compatible	DOC26	Length: 2m Pin Numbers and signal levels: RS-232C compatible
	DOC 27	D-sub connector: DOC26: 25 pins (female) DOC27: 9 pins (female)
Other computers	DOC1	No connector for attachment to a computer.

27.3 Target System

- Because all Sokkia reflecting prisms and accessories have standardized screws, it is possible to combine these prisms, accessories, etc. according to your objectives.
- The following are all special accessories (sold separately).
- Because these targets(*2) are coated with fluorescent paint, they reflect when there is little light.

Caution

- When using a reflecting prism equipped with a target for distance and angle measurements, be sure to direct the reflective prism correctly and sight the center of the prism target accurately.
- Each reflective prism(*1) has its own prism constant value. When changing prisms, be sure to change the prism constant correction value.
- To use the triple prism assembly AP31 or AP32 as a single prism for short distance measurements, mount the single reflective prism AP01 in the center mounting hole of the prism holder.

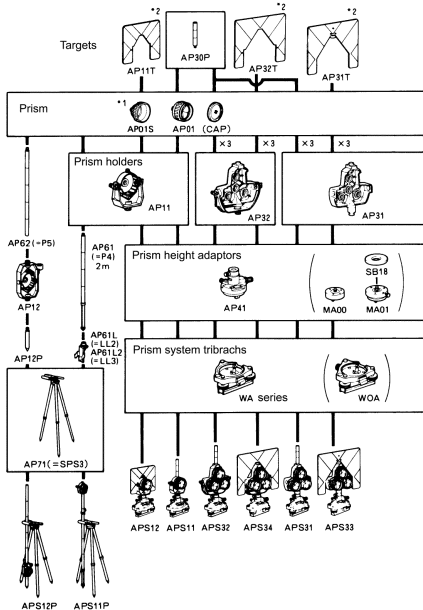

● 2-point target (2RT500-K)

This target is used for two-distance offset measurement.

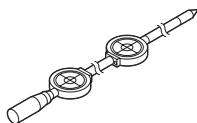

- For information about reflective sheet targets and target devices, contact your SOKKIA agent.

● Instrument height adaptor (AP41)

Adjust the level of the AP41 instrument height adaptor following the checking and adjustment methods of plate level.

"26.1 Plate Level"

Adjust the optical plummet of the AP41 instrument height adaptor following the checking and adjustment methods of optical plummet.

"26.6 Optical Plummet"

The height of the AP41 instrument height adaptor can be adjusted using two fixing screws. When used with the SET230R/330R/530R/630R, make sure that the instrument height "236" (mm) is displayed in the instrument height adjustment window.

Loosen the screws ① and rotate it counterclockwise ②. Move the part ③ up or down until the desired instrument height is displayed in the adjustment window ④, then rotate it clockwise and tighten the screws ⑤.

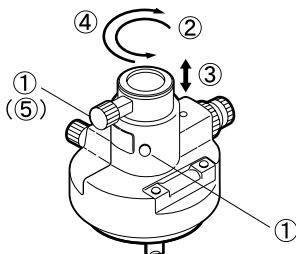

● Adjusting plate (WASeries)

Adjust the circular level of the adjusting plate for a prism following the checking and adjustment methods of circular level.

"26.2 Circular Level"

27.4 Power Supply System

Operate your SET with the following combinations of power equipment.

Caution

- Be sure to carefully read the operating manuals for the battery and charger before operating them.
- Never use any combination other than those indicated below. If you do, the SET could be damaged.

Those indicated by * are standard accessories.

Others are optional accessories (sold separately) for SET230R/330R/530R.

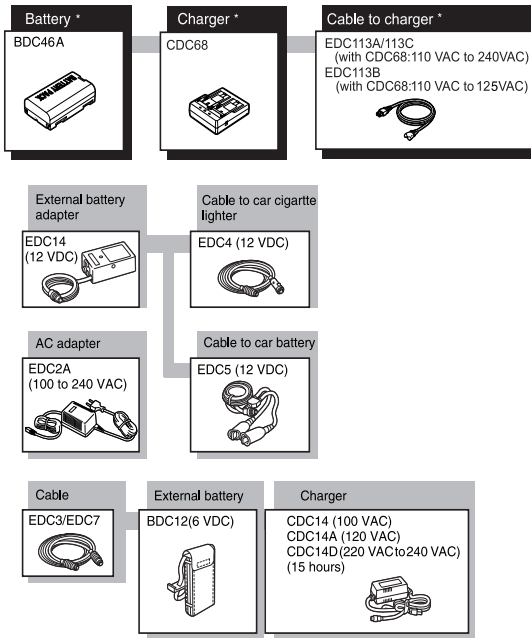

● External power supply equipment

- When using EDC14, EDC2A, or BDC12, mount the BDC46A in place to maintain the balance of the instrument.
- Make sure that the car cigarette lighter is 12V DC and that its negative terminal is grounded. Use it with the car engine running.
- The EDC14 has a breaker switch. Normally the red mark appears on the breaker. If it cannot be seen, set the breaker so it is visible.
When using the car battery, the breaker will cut off if the poles are not correctly connected.

28. SPECIFICATIONS

Except where stated, the following specifications apply to all SETs. "SET230R" means "SET230R/230R3", "SET330R" means "SET330R/330R3" and "SET530R" means "SET530R/530R3".

Telescope

Length:	171mm
Aperture:	45mm(EDM:48mm)
Magnification	
SET230R/330R/530R:	30X
SET630R:	26X
Image:	Erect
Resolving power:	
SET230R/330R/530R:	2.5"
SET630R:	3.5"
Field of view	1°30'
Minimum focus:	1.3m
Focussing screw:	1 speed
Reticle illumination:	5 brightness levels

Angle measurement

Horizontal and Vertical circles type:

Rotary absolute encoder

Angle units: Degree/Gon/Mil (selectable)

Minimum display: 1" (0.0002gon/0.005mil)/5" (0.0010gon/0.02mil) (selectable)

Accuracy:

 SET230R: 2" (0.0006gon/0.010mil)

 SET330R: 3" (0.0010gon/0.015mil) (When "Minimum display" is set to 1")

 SET530R: 5" (0.0015gon/0.02mil)

 SET630R: 6" (0.0019gon/0.025mil)

(ISO 12857-2 :1997)

Measuring time: Less than 0.5 sec

Automatic compensator: ON (V & H/V)/OFF (selectable)

 Type: Liquid 2-axis tilt sensor

 Minimum display: Agrees with minimum displayed measurement angle

 Range of compensation: $\pm 3'$

Measuring mode:

 Horizontal angle: Right/Left (selectable)

 Vertical angle: Zenith/Horizontal/Horizontal $\pm 90^\circ$ /% (selectable)

28. SPECIFICATIONS

Distance Measurement

Measuring method:	Coaxial phase-contrast measuring system
Signal source:	Red laser diode 690nm
SET230R/330R/530R/630R :	Class 2
SET230R3/330R3/530R3:	Class 3R (IEC60825-1 Amd. 2: 2001/ FDA CDRH 21CFR Part1040.10 and 1040.11 (Complies with FDA performance standards for laser products except for deviations pursuant to Laser Notice No.50, dated July 26, 2001.)) (When the prism or reflective sheet is selected in Config mode as target, the output is equivalent to Class 1).
Measuring range:	(Using Sokkia's reflective prism/reflective sheet target during normal atmospheric conditions *1 / *2 is good atmospheric conditions)
SET230R/330R/530R:	Reflective sheet RS90N-K: 1.3 to 500 m (1,640ft) Reflective sheet RS50N-K: 1.3 to 300 m (980ft) Reflective sheet RS10N-K: 1.3 to 100 m (320ft) Compact prism CP01: 1.3 to 800 m (2,620ft) Standard prism AP01 X 1: 1.3 to 4,000 m (13,120ft) 1.3 to 5,000m (16,400ft) *2 Standard prism AP01 X 3: to 5,000 m (16,400ft) to 6,000m (19,680ft)*2 Mini pole prism OR1PA: 1.3 to 500 m (1,640ft) Reflectorless (White) *3 :
	SET230R/330R/530R: 0.3 to 150m (490ft) SET230R3/330R3/530R3: 0.3 to 350m (1,140ft) Reflectorless (Gray) *4 :
	SET230R/330R/530R: 0.3 to 80m (260ft) SET230R3/330R3/530R3:0.3to170m(550ft)
SET630R:	Reflective sheet RS90N-K: 1.3 to 500 m (1,640ft) Reflective sheet RS50N-K: 1.3 to 300 m (980ft) Reflective sheet RS10N-K: 1.3 to 100 m (320ft) Compact prism CP01: 1.3 to 800 m (2,620ft) Standard prism AP01 X 1: 1.3 to 3,000 m (9,840ft) 1.3 to 4,000m (13,120ft) *2 Standard prism AP01 X 3: to 4,000 m (13,120ft) to 5,000m (16,400ft)*2 Mini pole prism OR1PA: 1.3 to 500 m (1,640ft) Reflectorless (White) *3: 0.3 to 100m (320ft) Reflectorless (Gray) *4: 0.3 to 50m (160ft)

Minimum display:

Fine/Rapid measurement: 0.001 m (0.01ft / 1/8inch)

Tracking measurement: 0.01 m (0.1ft / 1/2inch)

Maximum slope distance:

Prism/ reflective sheet: 9599.999 m (31,496ft)

Reflectorless: 599.999m (1,968.5ft)

Distance unit:

m/ft/inch (selectable)

Accuracy:

(Using prism)

Fine measurement: $\pm(2 + 2 \text{ ppm X D})$ mmRapid measurement (single): $\pm(5 + 2 \text{ ppm X D})$ mm

(Using reflective sheet target)

Fine measurement: $\pm(3 + 2 \text{ ppm X D})$ mmRapid measurement (single): $\pm(6 + 2 \text{ ppm X D})$ mm(Reflectorless (White))***3**

SET230R/330R/530R:

Fine measurement:

 $\pm(3 + 2 \text{ ppm X D})$ mm (0.3 to 100m) $\pm(5 + 10 \text{ ppm X D})$ mm (over 100 to 150m)

Rapid measurement (single):

 $\pm(6 + 2 \text{ ppm X D})$ mm (0.3 to 100m) $\pm(8 + 10 \text{ ppm X D})$ mm (over 100 to 150m)

SET230R3/330R3/530R3:

Fine measurement:

 $\pm(3 + 2\text{ppm X D})$ mm (0.3 to 200m) $\pm(5 + 10\text{ppm X D})$ mm (over 200 to 350m)

Rapid measurement (single):

 $\pm(6 + 2\text{ppm X D})$ mm (0.3 to 200m) $\pm(8 + 10\text{ppm X D})$ mm (over 200 to 350m)

SET630R:

Fine measurement: $\pm(3 + 2 \text{ ppm X D})$ mmRapid measurement (single): $\pm(6 + 2 \text{ ppm X D})$ mm(Reflectorless (Gray))***4**

SET230R/330R/530R:

Fine measurement:

 $\pm(3 + 2\text{ppm X D})$ mm (0.3 to 45m) $\pm(5 + 5\text{ppm X D})$ mm (over 45 to 80m)

Rapid measurement (single):

 $\pm(6 + 2\text{ppm X D})$ mm (0.3 to 45m) $\pm(8 + 5\text{ppm X D})$ mm (over 45 to 80m)

SET230R3/330R3/530R3:

Fine measurement:

 $\pm(3 + 2\text{ppm X D})$ mm (0.3 to 100m) $\pm(5 + 5\text{ppm X D})$ mm (over 100 to 170m)

Rapid measurement (single):

 $\pm(6 + 2\text{ppm X D})$ mm (0.3 to 100m) $\pm(8 + 5\text{ppm X D})$ mm (over 100 to 170m)

28. SPECIFICATIONS

SET630R: Fine measurement:
 $\pm(3 + 2\text{ppm} \times D)$ mm (0.3 to 30m)
 $\pm(5 + 5\text{ppm} \times D)$ mm (over 30 to 50m)
Rapid measurement (single):
 $\pm(6 + 2\text{ppm} \times D)$ mm (0.3 to 30m)
 $\pm(8 + 5\text{ppm} \times D)$ mm (over 30 to 50m)

(D: measurement distance; Unit: mm)

Measurement mode: Fine measurement (single/repeat/average)/
Rapid measurement (single) /Tracking
(selectable)

Measuring time:

Fine measurement: 2.6 sec + every 1.3 sec.

Rapid measurement (single) 1.8 sec

Tracking measurement: 1.6 sec + every 0.3 sec.

Atmospheric correction:

Temperature input range:- 30 to 60°C (in 1°C step)/ - 22 to 140°F (in 1°F step)

Pressure input range: 500 to 1,400 hPa (in 1hPa step)
375 to 1,050 mmHg (in 1mmHg step)
14.8 to 41.3 inchHg (in 0.1inchHg step)

ppm input range: -499 to 499 ppm (in 1 ppm step)

Prism constant correction: -99 to 99 mm (in 1 mm step)

0mm fixed for reflectorless measurement

Earth curvature and refraction correction:

No/Yes K=0.142 /Yes K=0.20 (selectable)

- *1: Slight haze, visibility about 20 km, sunny periods, weak scintillation.
- *2: No haze, visibility about 40 km, overcast, no scintillation.
- *3: Figures when using Kodak Gray Card White side (reflection factor 90%) and brightness level is less than 30000 lx (a little cloudy).
- *4: Figures when using Kodak Gray Card Gray side (reflection factor 18%) and brightness level is less than 30000 lx (a little cloudy).
- *3,*4: When performing reflectorless measurement, the possible measurement range and precision will change depending on the target reflection factor, weather conditions and location conditions.

Power Supply

Power source: Rechargeable Li-ion battery BDC46A
External battery BDC12 (Option)

Battery state indicator: 4 levels

Working duration at 25 °C:

Distance and angle measurement

(Fine single measurement = every 30 sec.) :

BDC46A:

SET230R/330R/530R/630R: about 6 hours

SET230R3/330R3/530R3: about 5.5 hours

BDC12:

SET230R/330R/530R/630R: about 22.5 hours

SET230R3/330R3/530R3: about 22 hours

Angle measurement only:

BDC46A: about 8.5 hours

BDC12:

SET230R/330R/530R/630R: about 30 hours

SET230R3/330R3/530R3: about 29 hours

Charging time at 25 °C:

BDC46A

about 2 hours (using CDC68) *5

Nominal voltage: 7.2V

Storage temperature range: -20 to 35 °C

CDC68

Input voltage:

with EDC113A/113C: 110 to 240 VAC 50/60Hz

with EDC113B: 110 to 125 VAC 50/60Hz

Charging temperature range: 0 to 40 °C

Storage temperature range: -20 to 65 °C

*5: Charging can take more than 2 hours when temperatures are either especially high or low.

General

Display:

LCD graphic display, 192 dots X 80 dots

SET230R/330R/530R: 1 LCD graphic displays on each face with illuminator

SET630R: 1 LCD graphic display with illuminator

Operation panel (keyboard):

15 keys (soft function, operations, power on, light)

Auto power-off:

5 levels (selectable)

Laser sighting function:

Provided On/Off (selectable)

Internal memory:

about 10,000points

Data output:

Asynchronous serial, RS232C compatible

Centronics compatible (with DOC46A)

Printer with ESC/PTM mode (emulation function)

Sensitivity of levels:

Plate level:

SET230R: 20"/2 mm

SET330R /530R: 30"/2 mm

SET630R: 40"/2 mm

Circular level:

10"/2 mm

28. SPECIFICATIONS

Optical plummet:

Image:	Erect
Magnification:	3X
Minimum focus:	0.3 m

Horizontal and vertical motion screw:

SET230R:	2 speed
SET330R/530R/630R:	1 speed

Operating temperature: -20 to 50 °C

Storage temperature range: -30 to 70 °C

Dust and water resistance: IP66 (IEC 60529: 1989)

Instrument height: 236 mm from tribrach bottom

Size (with handle): 165 (W) X 171 (D) X 341 (H) mm

Weight (with handle and battery):

SET230R:	5.4kg (12.0lb) *6
SET330R/530R:	5.4kg (11.9lb) *6
SET630R:	5.3kg (11.6lb)

- *6: There is a slight difference in weight of horizontal and vertical fine motion screws between the SET230R and SET330R/530R. This difference is reflected in the weight for pounds but not for kilograms which has been rounded off to the nearest tenth.

29. REGULATIONS

Radio Frequency Interference

WARNING: Changes or modifications to this unit not expressly approved by the party responsible for compliance could void the user's authority to operate the equipment.

NOTE: This equipment has been tested and found to comply with the limits for a Class A digital device pursuant to Part 15 of the FCC Rules. These limits are designed to provide reasonable protection against harmful interference when the equipment is operated in a commercial environment. This equipment generates, uses, and can radiate radio frequency energy and, if not installed and used in accordance with the instruction manual, may cause harmful interference to radio communications. Operation of this equipment in a residential area is likely to cause harmful interference in which case the user will be required to correct the interference at his own expense.

Notice for Canada

This Class A digital apparatus meets all requirements of Canadian Interference-Causing Equipment Regulations.

Cet appareil numérique de la Class A respecte toutes les exigences du Règlement sur le matériel brouilleur du Canada.

CE Conformity Declaration



CE Conformity Declaration
in accordance with EMC Directive 89/336/EEC of the European Community

We herewith declare that the undermentioned instrument, in view of its design and type of construction, fully complies with the relevant basic radio interference requirements of the EMC Directive.
Should the instrument be modified without agreement, this declaration becomes invalid.

Instrument Description: Non Prism Electronic Total Station (Surveying Instruments)
SET230R(with option SCRC2A),SET230RS(with option SCRC2A),
SET330R(with option SCRC2A),SET330RS(with option SCRC2A),
SET530R(with option SCRC2A),SET530RS(with option SCRC2A),

Model Name : SET630R,SET630RS
SET230R3(with SCRC2A),SET230R3S(with SCRC2A),
SET330R3(with SCRC2A),SET330R3S(with SCRC2A),
SET530R3(with SCRC2A),SET530R3S(with SCRC2A),

Relevant EC Directive: EMC Directive (89/336/EEC)
Version: 92/31/EEC, 93/68/EEC

Applied Harmonized Standard: EMI EN55011 1998/A1:1999
EMS EN61000-6-2 1999

Date: 03-06-2003

Firm: SOKKIA B.V.

Address: Industrieterrein De Vaart, Damsluisweg 1, NL-1332 EA Almere

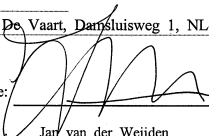
Representative's Signature: 

Name of Representative : Jan van der Weijden

Representative's position : Managing Director

CE Conformity Declaration

in accordance with EMC Directive 89/336/EEC of the European Community

We herewith declare that the undermentioned instrument, in view of its design and type of construction, fully complies with the relevant basic radio interference requirements of the EMC Directive.

Should the instrument be modified without agreement, this declaration becomes invalid.

Instrument Description: Wireless keyboard

Model Name : SF14

Relevant EC Directive: EMC Directive (89/336/EEC)
Version: 91/263/EEC, 92/31/EEC, 93/68/EEC

Applied

Harmonized Standard: EMI EN55022 Class B:1994 +A1:1995+A2:1997

EMS IEC61000-4-2:1999, IEC61000-4-3:1995, ENV50204:1995,
IEC61000-4-4:1995, IEC61000-4-8:1993

Date: 07 November 2001

Firm: SOKKIA B.V.

Address: Industrieterrein De Vaart, Damsluisweg 1, NL-1332 EA Almere

Representative's Signature: _____

Name of Representative : Jan van der Weijden

Representative's position : Managing Director

30. EXPLANATION

30.1 Manually Indexing the Vertical Circle by Face Left, Face Right Measurement

The 0 index of the vertical circle of your SET is almost 100% accurate, but when it is necessary to perform particularly high precision angle measurements, you can eliminate any inaccuracy of the 0 index as follows.

Caution

- If the power is cut off, the vertical circle indexing is ineffective. Do it again every time the power is turned on.

►PROCEDURE Manually indexing the vertical circle

1. Select "Obs. condition" in <Config>. Set "V manual" (vertical circle indexing method) to "Yes."

2. Go to the Meas mode screen. The vertical angle V1 is displayed under "Take F1."

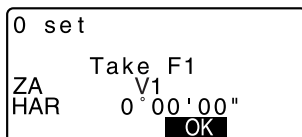

```
0 set
      Take F1
ZA    V1
HAR   0°00'00"
      OK
```

3. Carefully level the instrument.

4. Accurately sight a clear target with a distance of about 30m in the horizontal direction with the telescope in face left.

Press **[OK]**. The vertical angle V2 is displayed under "Take F2."

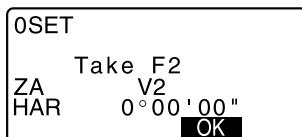

```
0SET
      Take F2
ZA    V2
HAR   0°00'00"
      OK
```

5. Turn the upper part through 180° and clamp it. Then set the telescope in the face right position and accurately sight the same target.

Press **[OK]**.

The vertical and horizontal angles are displayed.

This concludes the vertical circle indexing procedure.

30.2 Atmospheric Correction for High Precision Distance Measurement

- Need for atmospheric correction

The SET measures the distance with a beam of light, but the velocity of this light varies according to the index of refraction of light in the atmosphere. This index of refraction varies according to the temperature and pressure. Near normal temperature and pressure conditions:

With constant pressure, a temperature change of 1°: an index change of 1 ppm.

With constant temperature, a pressure change of 3.6 hPa: an index change of 1 ppm.

To perform high accuracy measurements, it is necessary to find the atmospheric correction factor from even more accurate temperature and pressure measurements and perform an atmospheric correction.

Sokkia recommends that extremely precise instruments be used to monitor the air temperature and pressure.

- Finding the average temperature and pressure between two points in different atmospheric conditions

To precisely determine the atmospheric correction factor, the average temperature and air pressure along the measurement beam route must be taken.

Determine the temperature and pressure as follows.

Flat terrain :Use the temperature and pressure at the midpoint of the line.

Mountainous terrain :Use the temperature and pressure at the intermediate point (C).

If it is not possible to measure the temperature and pressure at the midpoint, take the temperature and pressure at the instrument station (A) and the target station (B), then calculate the average value.

Average air temperature : $(t_1 + t_2) / 2$

Average air pressure : $(p_1 + p_2) / 2$

30. EXPLANATION

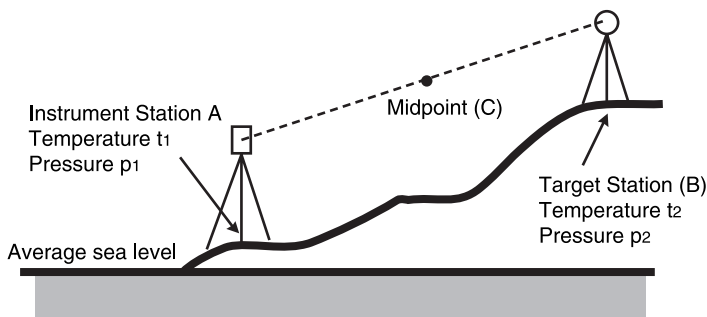

- Calculation of atmospheric correction factor allowing for humidity
The humidity has little influence, particularly on short distance measurements. The effect of humidity should be considered in cases where it is very hot and humid and high precision measurements are to be performed over a particularly long distance.

When taking humidity into consideration, enter the atmospheric correction factor calculated using the following formula.

Atmospheric Correction Factor (ppm) =

$$282.59 - \frac{0.2942 \times p}{1 + 0.003661 \times t} + \frac{0.0416 \times e}{1 + 0.003661 \times t}$$

e (water vapor pressure) can be calculated using the following formula.

$$e = h \times \frac{e_w}{100}$$
$$e_w = 6.11 \times 10^{\frac{(7.5 \times t)}{(t + 237.3)}}$$

t : Air temperature (°C)

p : Pressure (hPa)

e : Water vapor pressure (hPa)

h : Relative humidity (%)

e_w: Saturated water vapor pressure

SOKKIA Customer Service

SOKKIA CO.,LTD.

<http://www.sokkia.co.jp/english/>

INTERNATIONAL SALES DEPT.

260-63, HASE, ATSUGI, KANAGAWA, 243-0036

PHONE +81-46-248-7984 FAX +81-46-247-1731

SOKKIA CO.,LTD.

<http://www.sokkia.co.jp/english/>

260-63 HASE, ATSUGI, KANAGAWA, 243-0036 JAPAN
PHONE +81-46-248-0068 FAX +81-46-247-6866

8th ed. 13-0408 Printed in Japan

©2002 SOKKIA CO., LTD.